

**ONE- AND TWO-HOUSEHOLD KIT WITH PANEL AND COLOUR
7" HANDS-FREE MONITOR**

Ref. 1723/71 - 1723/72 (*)

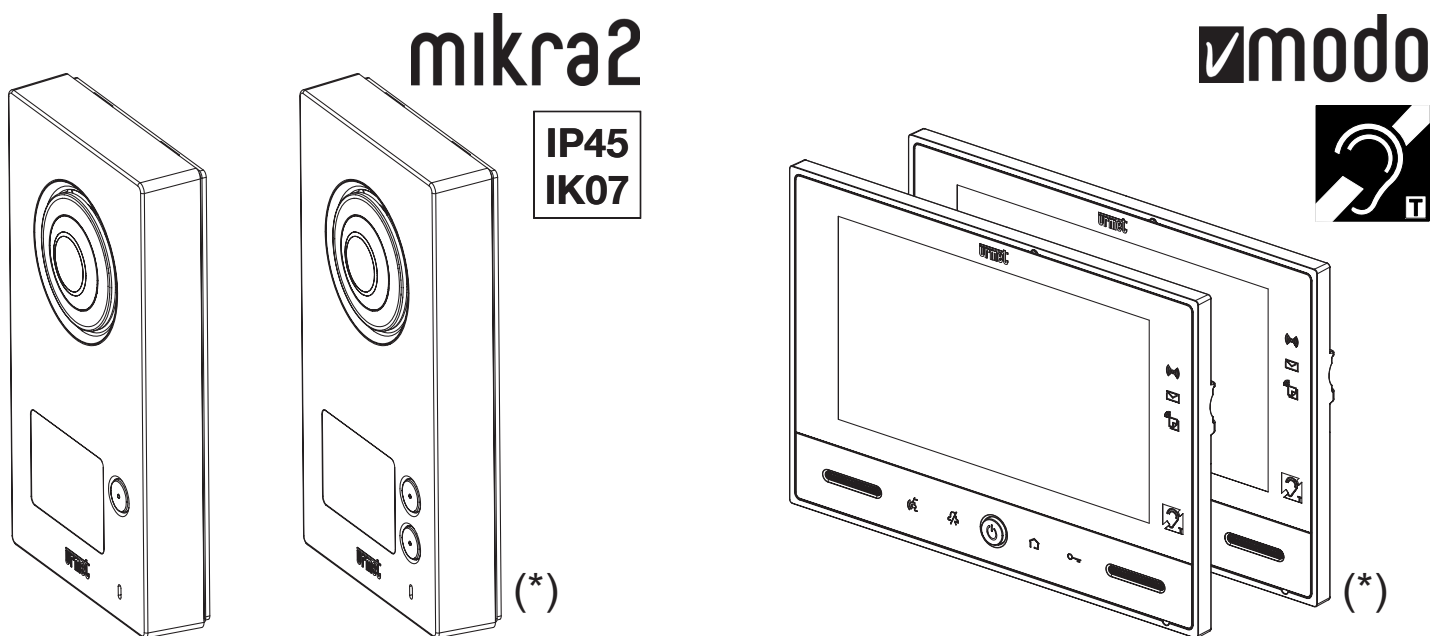

CONFIGURATION BOOKLET

TABLE OF CONTENTS

FIRST SWITCH-ON	3
INSTALLER SETTINGS	4
DOOR AND GATE OPENING SETTINGS	4
VIDEO SURVEILLANCE SETTING (E.G. FOR A WAITING ROOM).....	5
HOME AUTOMATION SETTINGS.....	6
BUTTON CONFIGURATION	7
BUTTON VISIBILITY	9
BUTTON CONFIGURATION STAIRS LIGHT	10
IMPORTING YOKIS BUTTONS FROM A REMOTE CONTROL OR VIDEO DOOR PHONE	10
EXPORTING YOKIS BUTTONS TO A REMOTE CONTROL OR VIDEO DOOR PHONE	11
RESETTING ALL ACCESS POINTS TO THE RADIO BUS.....	11
SETTING THE ALARM FUNCTION.....	11
CONTACT SETTING	14
LETTERBOX FUNCTION SETTING.....	15
INSTALLATION ON ONE-FAMILY KIT REF. 1723/71.....	15
INSTALLATION ON TWO-FAMILY KIT REF. 1723/72	16
CONFIGURATION.....	16
THERMOSTAT SETTING	17
CONNECTING THE TEMPERATURE SENSOR.....	17
WIRELESS CONNECTION OF THE THERMOSTAT TO THE BOILER	17
WIRED CONNECTION OF THE THERMOSTAT TO THE BOILER.....	17
ENDING CONFIGURATION.....	18
OFFICE WITH ATTACHED HOME SETTING	19
AUTOMATIC DOOR OPENER SETTING	20
TEST.....	22
VIDEO DOOR PHONE CALL TEST	22
CAMERA CONTROL TEST	24
ALARM FUNCTION TEST	25
ACTIVATION PROCEDURE	25
ALARM.....	25
PAST ALARM SIGNALLING (ALARM MEMORY)	26
DISARMING	26
HOW TO BROWSE VIDEO CLIPS	26
HOW TO BROWSE THE ALARM HISTORY	27
HOW TO SAVE THE ALARM HISTORY	28
LETTERBOX FUNCTION TEST	29
AUTOMATIC DOOR OPENER TEST.....	29
OFFICE WITH ATTACHED HOME SETTING	30
UPDATING THE VIDEO DOOR PHONE SOFTWARE.....	31
ACCESS CONTROL.....	32
KEY MEMORISATION PROCEDURE	32
KEY CANCELLATION PROCEDURE	33
ANNEXES	34
ANNEX A	34
How to configure Yokis buttons from the video door phone (without using the Yokis PRO app)	34
ANNEX B	41
How to import Yokis Buttons from remote control (or other video door phone).....	41
ANNEX C	43
How to configure the composite buttons	43

FIRST SWITCH-ON

The video door phone shows the language selection menu the first time it is switched on:



Tap on the required language and confirm by tapping on the  icon on the bottom right. The following will appear:

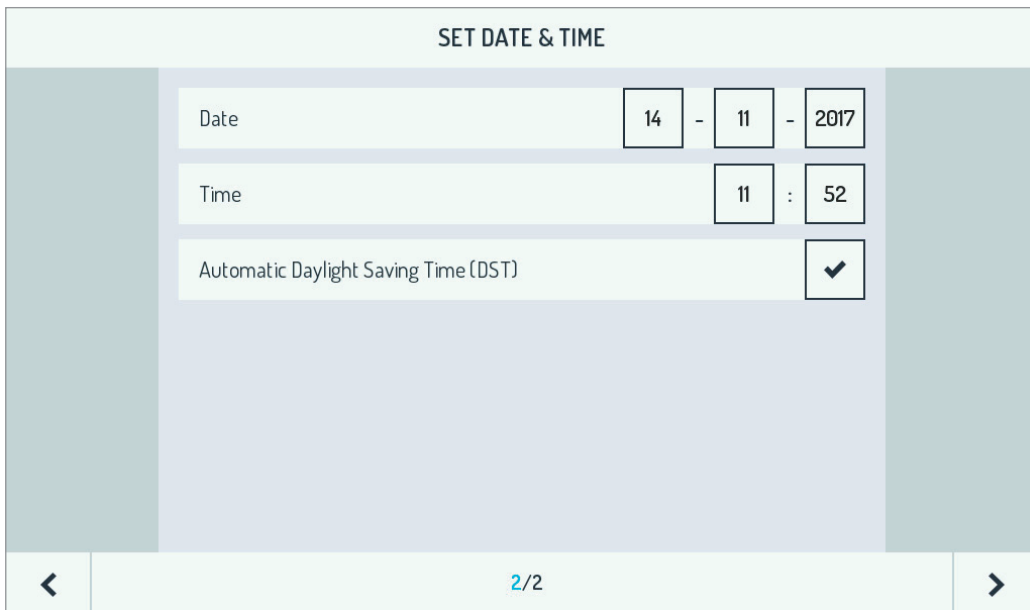

Set the current date and time⁽¹⁾.

It is advisable to select automatic daylight saving time in Europe as well⁽²⁾.

Tap on the  icon in the bottom right to confirm.

If necessary, the date and time can be set later. On any screen, tap on the clock icon in the bottom right to open the following window:

(1) When entering date and time, always clear the contents of the field FIRST and THEN enter the new required value. Tap on the required field to move from one field to the other.

(2) Warning. The switch from daylight saving time to standard time occurs at GMT. Consequently, in the Central European Time zone (France, Italy, Germany etc.), when switching from standard time to daylight saving time, the time is moved forwards by one hour at 1 o'clock at night (and not at 2 o'clock²). Similarly, when switching from daylight saving time to standard time, the time is moved back by one hour at 2 o'clock at night.

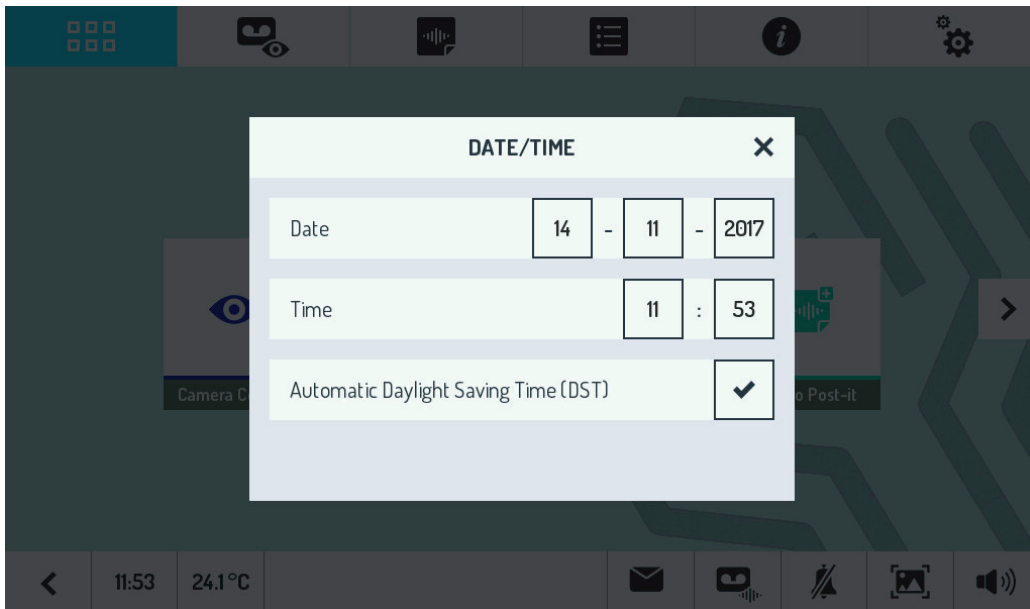

Alternatively, open the 'Configuration' menu using the  icon on the top right, select the 'User' menu and select 'Date & Time'. The following page will appear:

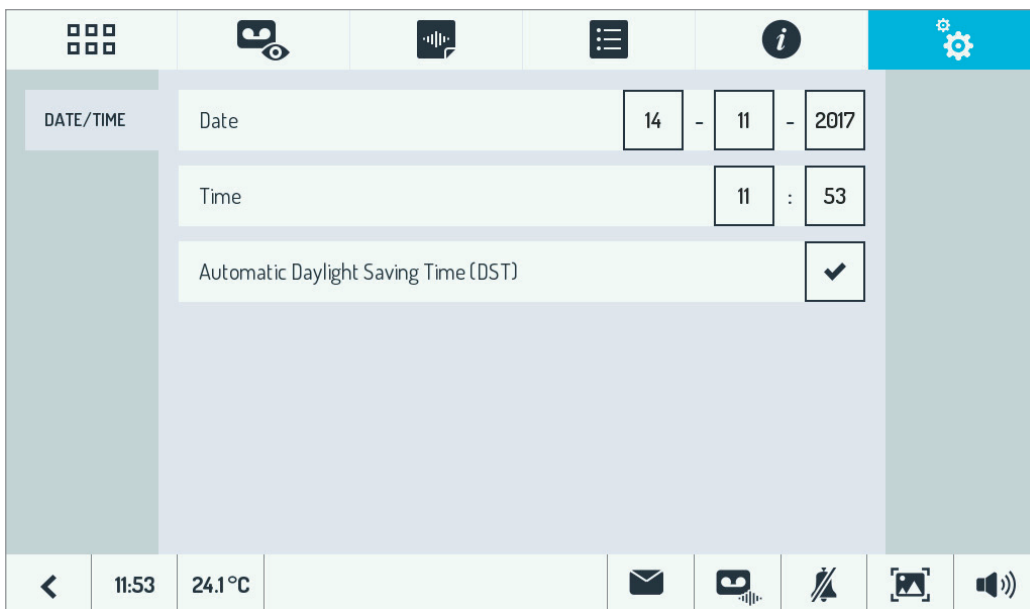

INSTALLER SETTINGS

To configure the video door phone functions using the 'Configuration' menu, which can be accessed by tapping on the  icon on the top right, select the 'Installer' menu and key in the installer password ('1937'). The password cannot be changed.

Using a password, even a weak one, provides a minimum level of protection from actions that the end user could change unintentionally.



WARNING. After having entered the password, the 'Installer' menu can be accessed (even multiple times) without needing to enter the password again for 10 minutes (fixed time). This simplifies operations during installation.

DOOR AND GATE OPENING SETTINGS

The kit allows flexible use to satisfy the most frequent installation types.

The various possibilities are listed below:

- 1) House with access door and automated gate (sliding or double)

You want to open the door by pressing  or  and open the gate by pressing  .
In this case, on the panel:

- Check that dip-switch 5 is in the OFF position (default).
- Connect the door lock to terminals SE+ and SE- (timed capacitive discharge).
- Connect the two N.O. terminals (low power relay) to the gate opener input (all open).
- If required, a button can be connected to the PA terminals to allow opening the door from the inside.
- If required, a button can be connected in parallel to the N.O. terminals to allow opening the gate from the inside.

2) House with automated gate only

You want to open the gate by pressing  .

In this case:

- Set dip-switch 5 to the ON position.
- Connect the two N.O. terminals (low power relay) to the gate opener input (all open).
- If required, a button can be connected in parallel to the N.O. terminals to allow opening the gate from the inside.

3) House with double gate, one part of which you want to use as a pedestrian crossing.

You want to open the first part of the gate by pressing  and open the second only by pressing  .

In this case:

- Check that dip-switch 5 is in the OFF position (default).
- Connect the terminals SE+ and SE- (timed capacitive discharge) to a decoupling relay and the output of the decoupling relay⁽³⁾ of the gate opener (open first part input).
- Connect the two N.O. terminals (low power relay) to the gate opener input (open second part input).
- If required, a button can be connected to the PA terminals to allow opening the first part of the gate from the inside.
- If required, a button can be connected in parallel to the N.O. terminals to allow opening the second part from the inside.

VIDEO SURVEILLANCE SETTING (E.G. FOR A WAITING ROOM)

A local camera can be connected to the video door phone (visible only from that same video door phone) and other four cameras by means of the interface Ref. 1723/69.

In the 'Configuration' menu which can be opened using the  icon on the top right, select the 'Installer' menu, type in the password ('1937') and select 'CCTV'.

The following will appear:

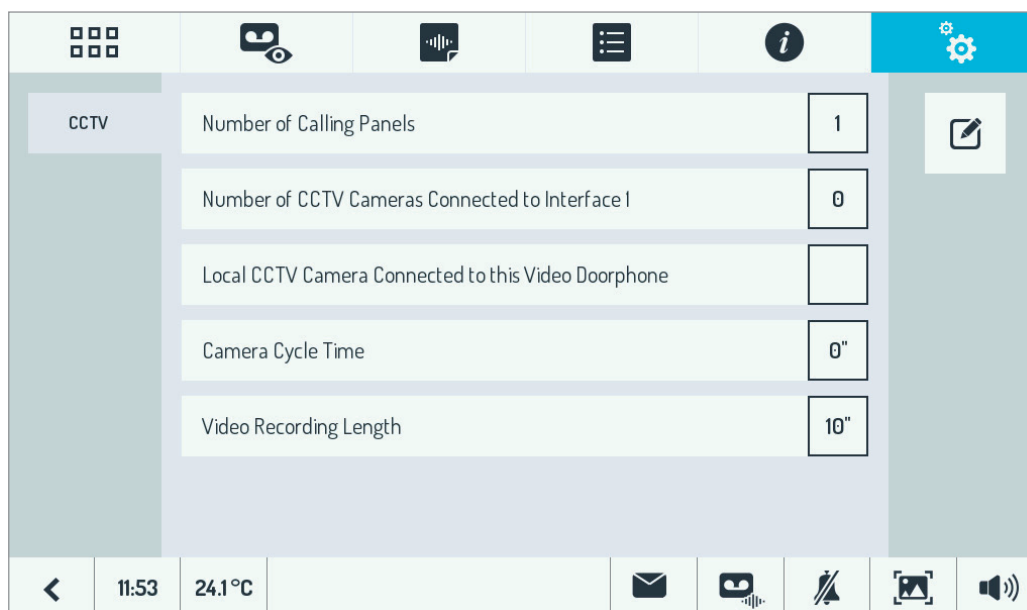

(3) In France, model 9406 with timer can be used.

Use the first three lines to specify which are the cameras present to the video door phone:

- The one or ones on the call stations (identification: 1 and possibly 2).
- The total number of those connected to the interface (identification: 3,4,5,6).
- The local one (identification: 7).

The fourth line can be used to specify whether or not you want a cyclic view on the cameras present:

- Set to 0 (default) to disable cyclic view.
- Set cycle time greater than zero, instead, to have the system automatically show the next camera image at the end of this time. The user can disable/enable cyclic view at any time.

On the fifth line, you can specify the duration of the video clips that the user can store when controlling the camera.

Finally, tap on the  icon on the top right you can assign specific names to the various controlled cameras:



The set names will appear superimposed on the image during the control phase.

 *The following characters, although available on the keyboard, cannot be used in the camera names: \ / : * ? " < > | _*

 *When multiple video door phones are present, different parameters can be set on different video door phones. During the camera control phase, the parameters of the current video door phone are used.*

HOME AUTOMATION SETTINGS

Each single video door phone has:

- Max. 8 buttons Yokis, equivalent to those of a Yokis remote control: BTN1...BTN8.
- Max. 6 composite buttons: Comp.BTN1...Comp.BTN6.
- Max. 2 buttons for operating local contacts: Contact1, Contact2.

To configure the home automation part, using the  icon on the top right, select the 'Installer' menu, type in the password ('1937') and select 'Home Automation'.

The following will appear:

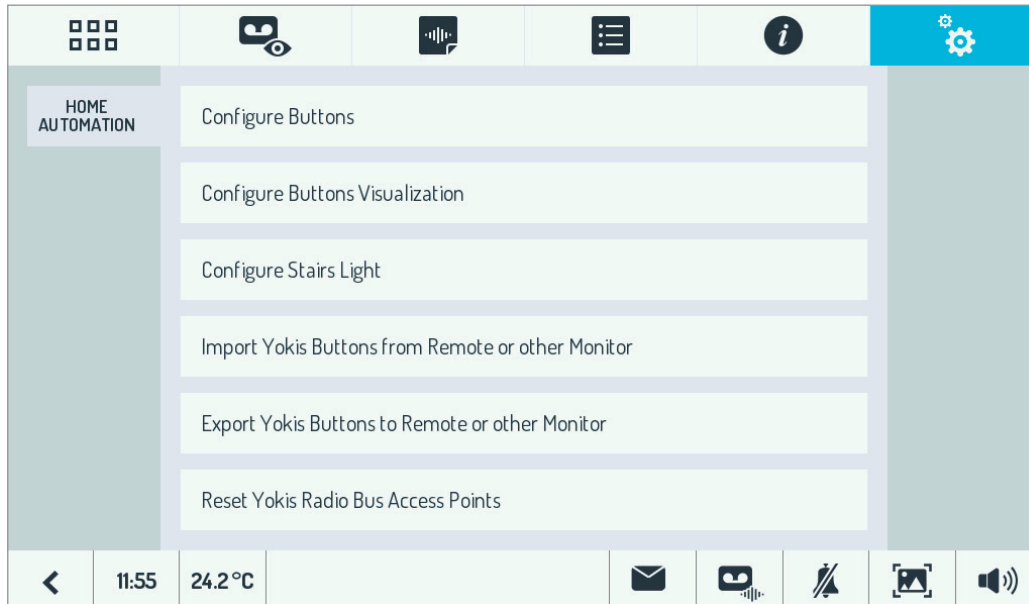

The first two items can be used to configure all buttons and to define which will be visible to the user and which will not.

The third item can be used to define the function of the Stairs Light button which appears during the call, e.g. to switch on the garden lights.

The fourth and the fifth items can be used to import the Yokis buttons from an eight-button remote control or other video door phone in the kit, but also to export the buttons to the devices.

The last item can be used to reset radio access points.

BUTTON CONFIGURATION

Select this item to open the complete page of all available buttons, regardless of their future visibility to the end user.

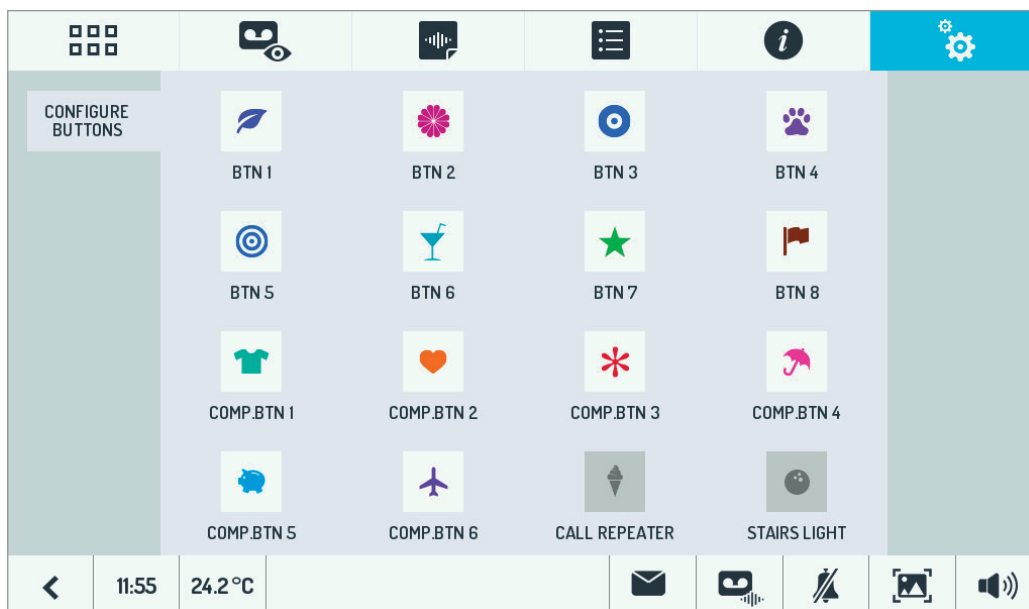

The first 8 buttons are Yokis buttons.

The camera to use for recording the video clip can be defined. They can be configured using the Yokis PRO app: start transferring the configuration from the Pro app and then press any button twice.

However, it is then necessary to assign a mnemonic name to them. Then tap on every single button used and give it the name of the function it performs, by selecting only the first item from the following menu:

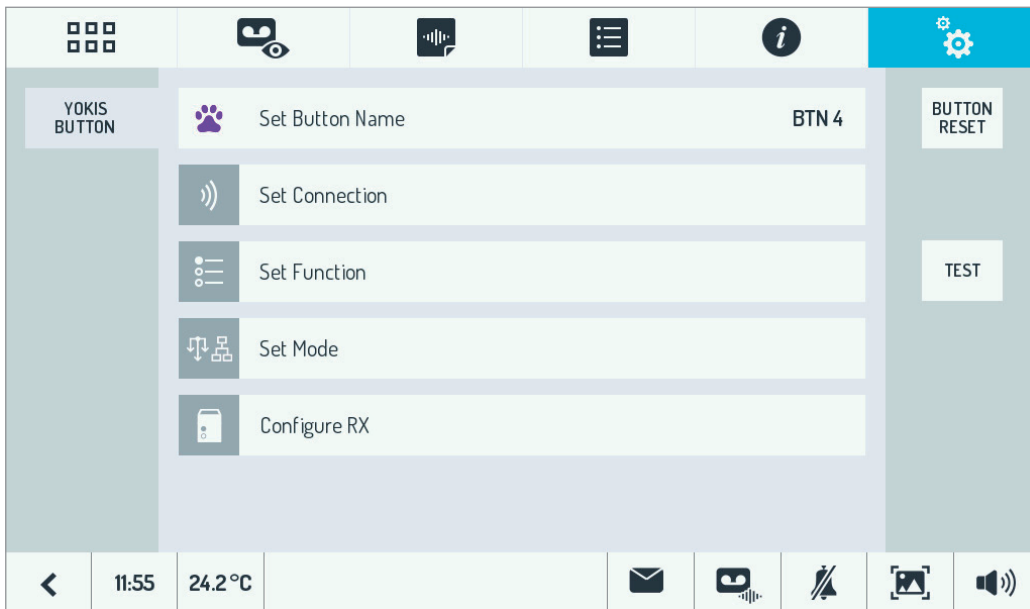

- Alternatively, the Yokis buttons can be configured without having to use an app:**
- **The single Yokis buttons can be configured directly by connecting them to the receivers: see how to proceed in Annex A.**
 - **The single Yokis buttons can be configured directly by importing them from an eight-button remote control: see how to proceed in Annex B.**

The next 6 buttons are composite buttons. Composite buttons can be used to control multiple Yokis buttons at the same time. In practice, for the end user, pressing a composite button will be equal to pressing the single Yokis buttons it consists of in sequence.

As in other kits, by tapping on a composite button you can set:

- The name of the button.
- The list of Yokis buttons which are part of the composition.
- The delay in the sequence of activations of buttons belonging to the composition, which is useful, for example, to avoid draw peaks in the case of actuation of shutters.
- The activation order of the selected Yokis buttons.

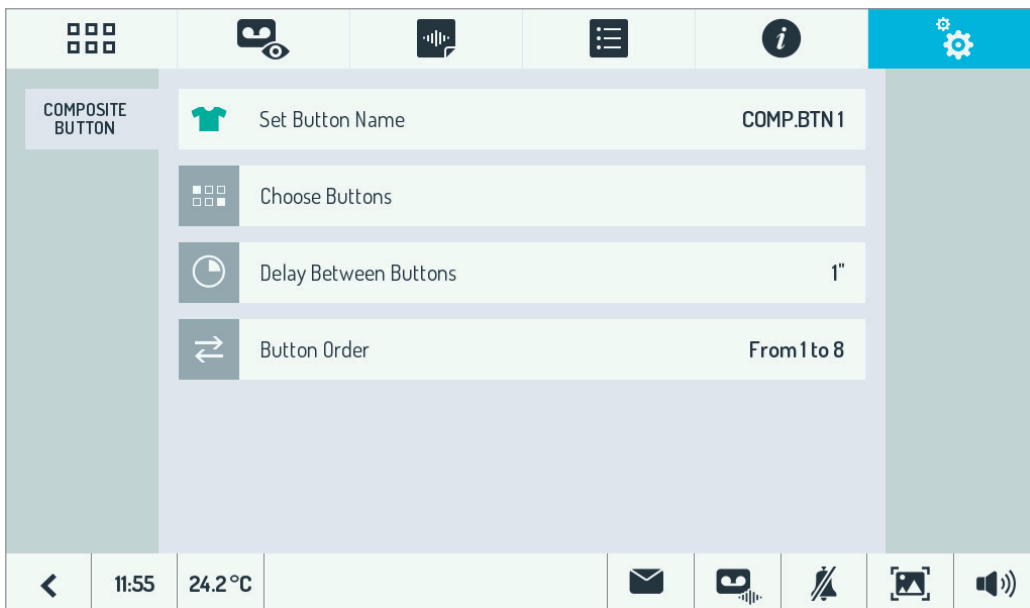

See **Annex C** for a more detailed description.

Finally, one or two buttons may appear which, when operated, activate the corresponding low power relays installed inside of the video door phone; contact 1 (monostable) for terminals 0,C and contact 2 (toggle) for the RELAY SPARE wired connection. The buttons appear only if the contacts have been 'allocated' to home automation (see below).

Touch Contact 1 or Contact 2 to configure the operation, by defining:

- The name of the button.
- The rest condition (Normally Open or Normally Closed contact).
- The operative method: Switching of the state each time it is pressed or pulse mode (with configurable pulse duration from 1 to 60 seconds).

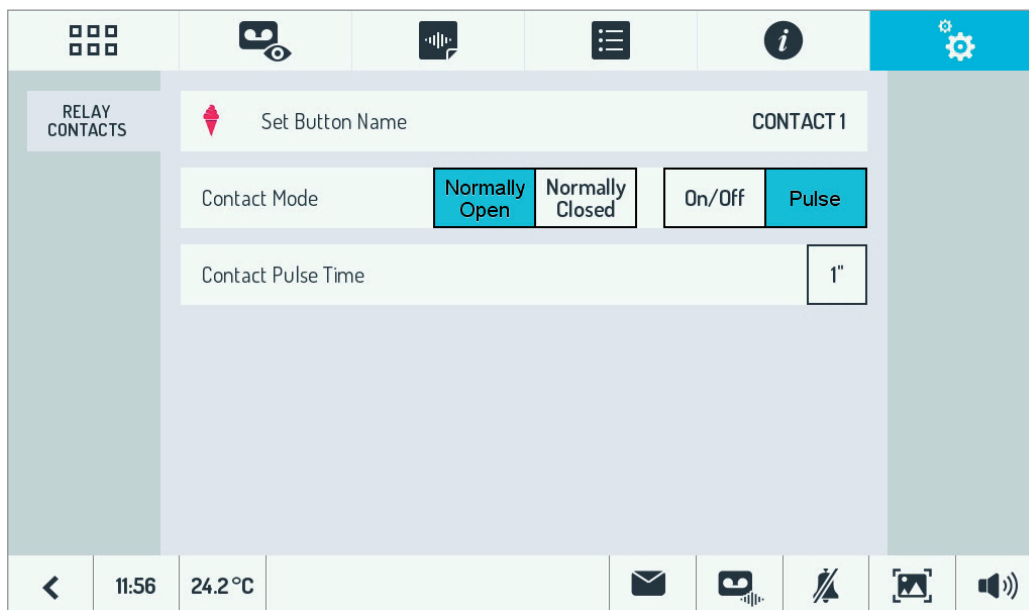

BUTTON VISIBILITY

It is often useful to make only the configured home automation buttons, i.e. only those which generate an action, visible to the final user.

The installer can therefore access to the specific configuration item in home automation and display the following page:

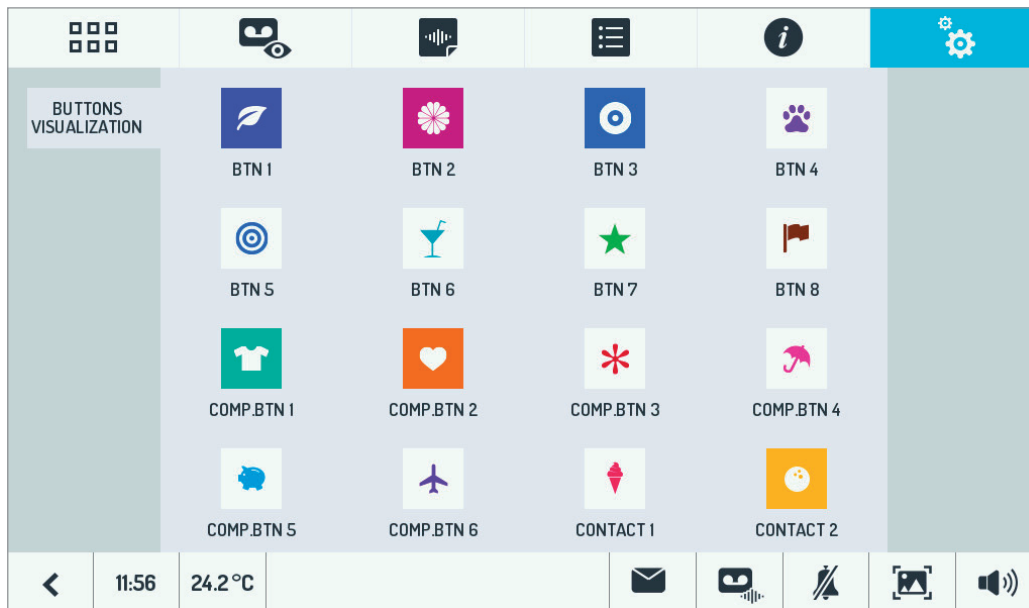

Each of icons can be tapped to make it switch status:

- Only the icons with coloured background will be 'visible' to the end user.
- The icons with white background will be 'hidden' from the end user.

If the installer selects six icons, as in the example below, the end user will only see six icons:

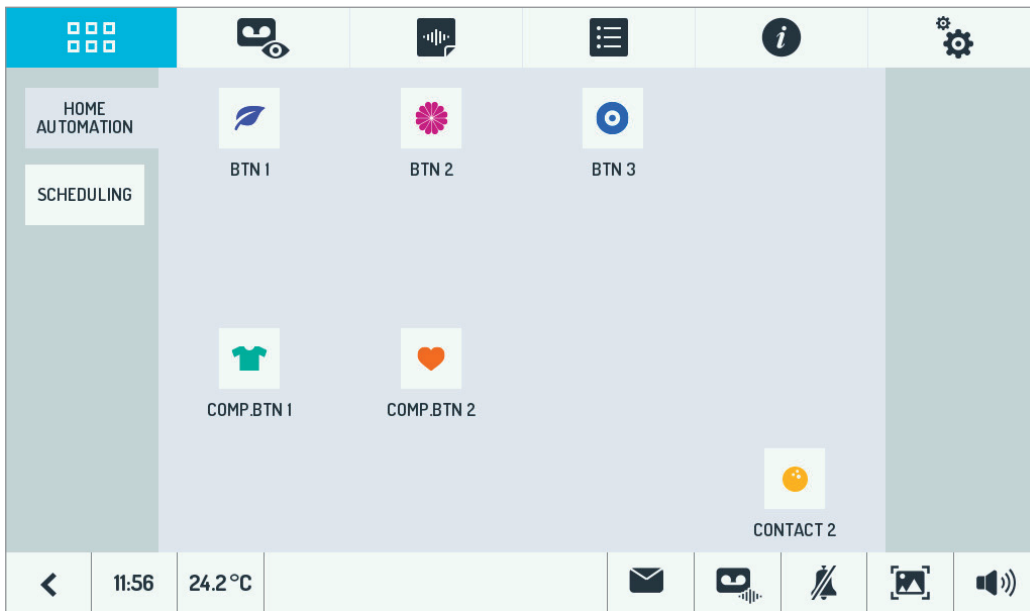

BUTTON CONFIGURATION STAIRS LIGHT

When answering a video door phone call, the user can press the  button to switch on the outside lights on the driveway, possibly in a timed manner, for instance.

When the user presses the button, one of 16 configured buttons will be activated.

During the configuration phase, it is therefore necessary to establish whether and which of the 16 buttons to activate.

The installer can therefore access to the specific configuration item in home automation and display the following page:

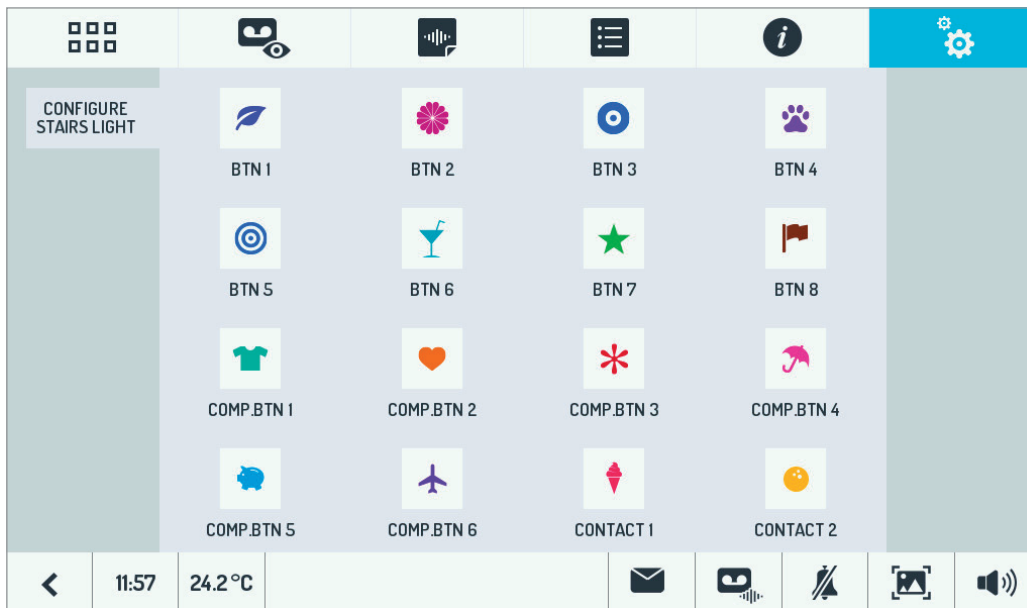

Tap on the icon you want to associate with the Stairs Light button⁽⁴⁾.

 If you want to delete an association, tap on the highlighted icon so that no icons are selected.

IMPORTING YOKIS BUTTONS FROM A REMOTE CONTROL OR VIDEO DOOR PHONE

The single Yokis buttons can be configured directly by importing them from an eight-button remote control. See Annex B for how to proceed in detail.

(4) **NOTE:** Once having associated a home automation button with the Stairs Light function, it will no longer be editable within the home automation settings (it will be greyed out). So, **FIRSTLY** configure the button (e.g. to connect it to the module Yokis and set the ON function to turn on the light) and **THEN** assign it to Stairs Light function.

EXPORTING YOKIS BUTTONS TO A REMOTE CONTROL OR VIDEO DOOR PHONE

The configuration of the eight Yokis buttons can be exported to a Yokis eight-button remote control or to another video door phone.

Selecting this item will automatically launch a Wizard.

RESETTING ALL ACCESS POINTS TO THE RADIO BUS

An access point can be used to control a specific remote receiver (or also more than one), positioned on Radio Bus.

More information can be found in the Yokis 'Radio Quick Installation Guide', in 'E: Range Extension with Radio Bus' and 'E-1: Definition of an Access Point to the Radio Bus'.

This option can be used to delete simultaneously all the access points of all buttons of the video door phone. Run **M 24**.

SETTING THE ALARM FUNCTION

The alarm function can be set to:

- Detect the opening of a door (e.g. the front door).
- Detect the energising of a motion sensor.

The occurrence of any one of these two events generates an alarm sequence.

Connect a Normally Closed (N.C.) magnetic sensor to the SP terminals of the door unit in order to detect the opening of a door near the input.

Also, check that dip-switch 1 is in the OFF position (default).⁽⁵⁾

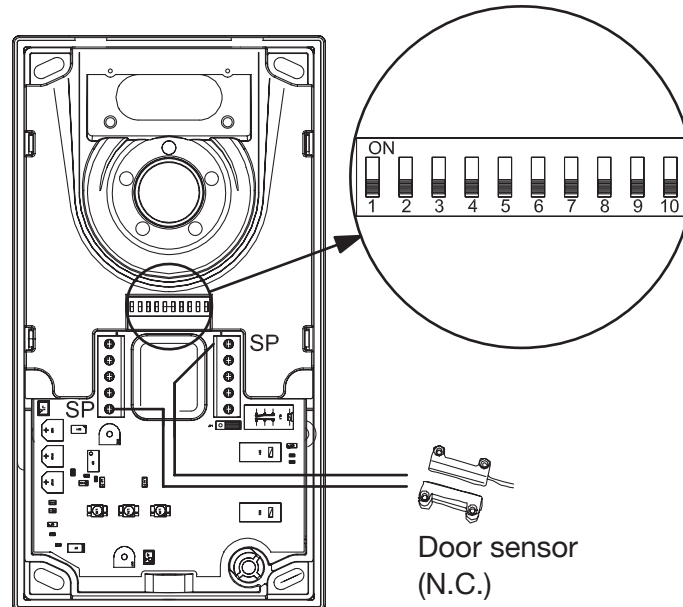

Connect a Normally Closed (N.C.) magnetic sensor to the AL terminals of the master video door phone in order to detect the opening of a door near the video door phone.

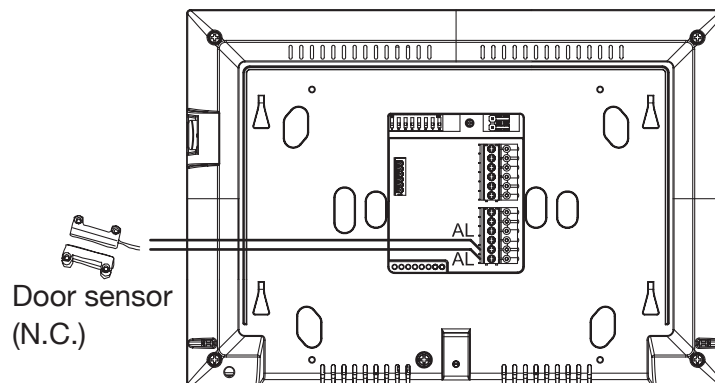

⁽⁵⁾ The alarm function cannot be used if the 'LETTERBOX' function is programmed (dip-switch 1 in the ON position): the two functions are mutually exclusive.

Follow the connection diagram below on the master video door phone to connect one or more motion sensors (in series).

WARNING. Specific settings are required in the 'Configuration' menu to use a motion sensor⁽⁶⁾.

Finally, if you want to provide an alarm signal on a siren (e.g. Urmet siren 1033/414), connect the siren to blue wires (SPARE RELAY) of the master video door phone.

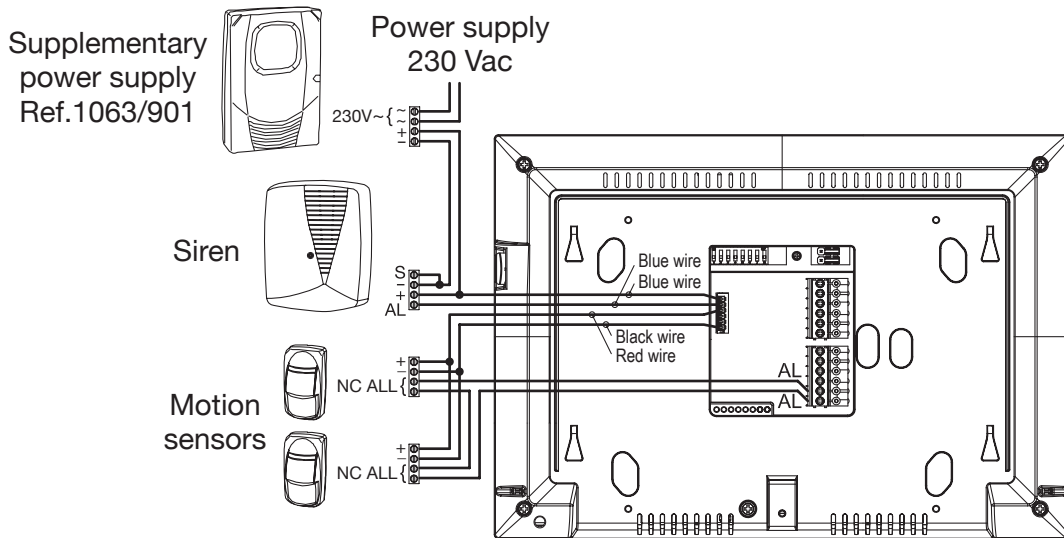

WARNING. Specific configurations steps are required to use of motion sensors and the siren.

In the 'Configuration' menu which can be opened using the  icon on the top right, select the 'Installer' menu, type in the password ('1937') and select 'Alarms'.

Most options relating to the alarm operating mode can be set in this way.

In particular, the following can be defined:

The exit and entrance times:

- Exit time: no alarm is generated if the sensor is energised during the exit time.
- Entrance time: with the alarm armed, the energising of the sensor will generate an alarm only after the entrance time.

To which devices to send an alarm signal .

- Enabling the alarm signal on the video door phone speaker.
- Enabling the alarm signal on a siren connected to the video door phone.
WARNING: Contact 2 must be configured as 'Alarm Siren'.
- Enabling of the alarm signal to simulate the pressing of a home automation button⁽⁷⁾. For example, the garden lights can be switched on if there is an alarm.
- Enabling the sending of the alarm signal to the CallMe app. In this case, the system must include an appropriately configured call forwarding device Ref. 1723/58.

(6) The use of motion sensor precludes the possibility of connecting a local camera to the video door phone: the two functions are mutually exclusive.

(7) NOTE: Once having set a home automation button to be recalled in case of alarm signal, it will no longer be editable within the home automation settings (it will be greyed out). So, you must configure the button (e.g. to connect it to the module Yokis and set the ON function to turn on the light) FIRST and THEN assign it to the alarm signal.

Whether to send power to the motion sensors, if this installation diagram is chosen⁽⁸⁾:

- Enable only in presence of motion sensors.

Whether to associate a video recording in case of alarm or not:

- Video recording can be enabled or not.
- A delay can be defined between the time in which the alarm was signal and the beginning of the video recording.
- The camera to use⁽⁹⁾ for recording the video clip can be defined.
- The encoding to use is:
 - 1: door panel camera.
 - 2: second panel camera (if present).
 - 3,4,5,6: cameras connected to the CCTV interface Ref. 1723/69.
- The duration of the video clips recorded in case of alarm.

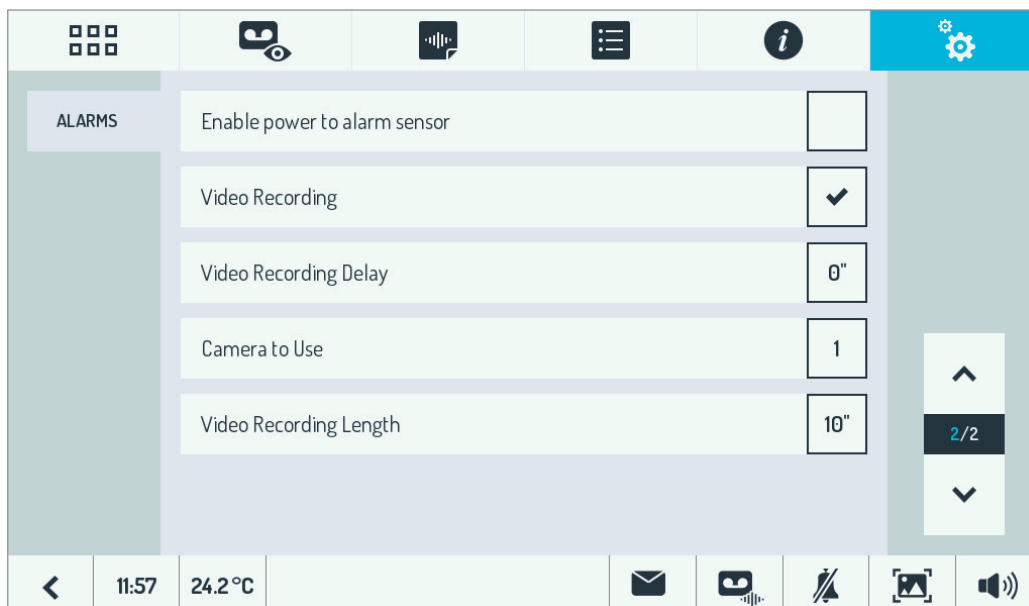

(8) The use of motion sensor precludes the possibility of connecting a local camera to the video door phone: the two functions are mutually exclusive.

(9) ONLY the cameras previously set in the video surveillance configuration will be presented as selectable. The local camera can not be used for this function.

CONTACT SETTING

The video door phone has two contacts:

- Contact 1 available on the two terminals 0, C.
- Contact 2 available on the two blue wires of the connector relay (RELAY SPARE).

These contacts can be used in various ways, according to needs.

WARNING. Both contacts are **LOW VOLTAGE** and must be appropriately decoupled if they are connected to equipment powered at 230Vac.

By default, the two contacts are configured in a manner compatible with that of the previous kit model Note:

- Contact 1 (0, C) can be used for the call repeat function. In this way, a call can be repeated on a supplementary ringer, either wired or wireless.

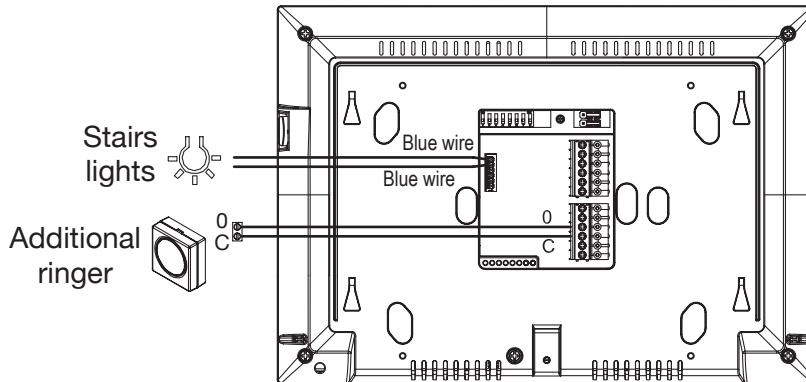

- Contact 2 (blue wire) can be directly used for controlling the stairs lights (or indirectly by means of appropriate decoupling device).

However, the functionality of these contacts can be modified.

In the 'Configuration' menu which can be opened using the  icon on the top right, select the 'Installer' menu, type in the password ('1937') and select 'Relay Contacts' and select one of the two contacts.

Contact 1 can be used to:

- Repeat the call (DEFAULT)
- As a normal home automation contact which can be controlled from the home automation page.
- Control the alarm siren (see Alarms paragraph).

Contact 2 can be configured as:

- Normal home automation contact (default), associable to the function Stairs Light (default).
- Contact for controlling the alarm siren (see Alarms paragraph).
- Physical contact of thermostat output (alternatively to a wireless contact).

WARNING The product software runs a number of cross checks to help the installer configure the device in the predetermined mode. As a result, some choices will be prevented according to how the contacts are configured.

If for example Contact 2 is assigned to controlling the alarm siren, on the home automation page it will not be possible to associate the Stairs Light function with Contact 2, and so forth.

LETTERBOX FUNCTION SETTING

INSTALLATION ON ONE-FAMILY KIT REF. 1723/71

On the letterbox, position two magnetic contacts near the front flap (mail introduction slot) and at the back (mail collection door).

The first contact (mail introduction slot) must be connected to the green and white wires of an E2BPP(X).

The second contact (mail collection door) must be connected to the brown and white wires of the same E2BPP(X).

On the control panel of the kit, connect a Yokis REL1C relay to the SP terminals and to the relay an appropriately powered MTR2000ERP(X) receiver⁽¹⁰⁾.

Follow the directions in the following diagram.

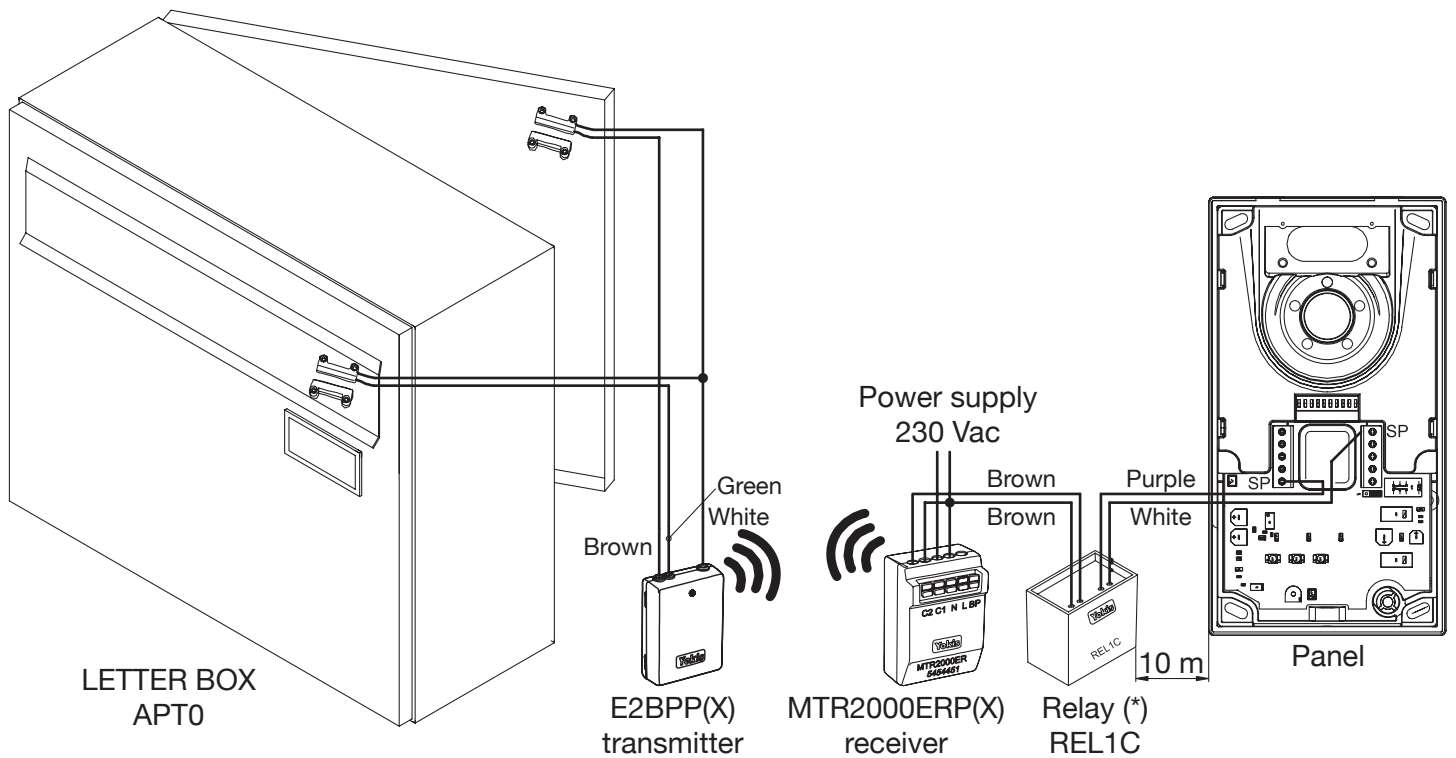

(*) WARNING. THE USE OF THE REL1C RELAY IS MANDATORY. IT ENSURES THE INSULATION BETWEEN THE LOW WORKING VOLTAGE OF THE KIT AND THE 230Vac VOLTAGE AT WHICH THE MTR2000ERP(X) RELAY IS POWERED. FAILURE TO USE THE REL1C RELAY WILL INVALIDATE ALL WARRANTIES.

Configure the devices as shown in the 'Configuration' chapter (see below).

⁽¹⁰⁾ In order to use the LETTERBOX function, the E2BPP(X) and E4BPP(X) modules must run firmware version FV1216 (or later) and the MTR2000ERP(X) modules must run firmware version FV1026 (or later). If the modules have an earlier firmware, you can update them using the Android "Yokis PRO" app which can be downloaded from official playstore.

INSTALLATION ON TWO-FAMILY KIT REF. 1723/72

On each letterbox, of both apartments (0,1) position two magnetic contacts near the front flap (mail introduction flap) and at the back (mail collection door).

Apartment number	Description of the magnetic contact function	Connection of the magnetic contact to the E4BPP(X) transmitter on the wires:
0	Mail introduction slot	Green - White
	Mail collection door	Brown - White
1	Mail introduction slot	Purple - White
	Mail collection door	Grey - White

On the control panel of the kit, connect a Yokis REL1C relay to the SP terminals and an appropriately powered receiver MTR2000ERP(X) to the relay.

Follow the directions in the following diagram.

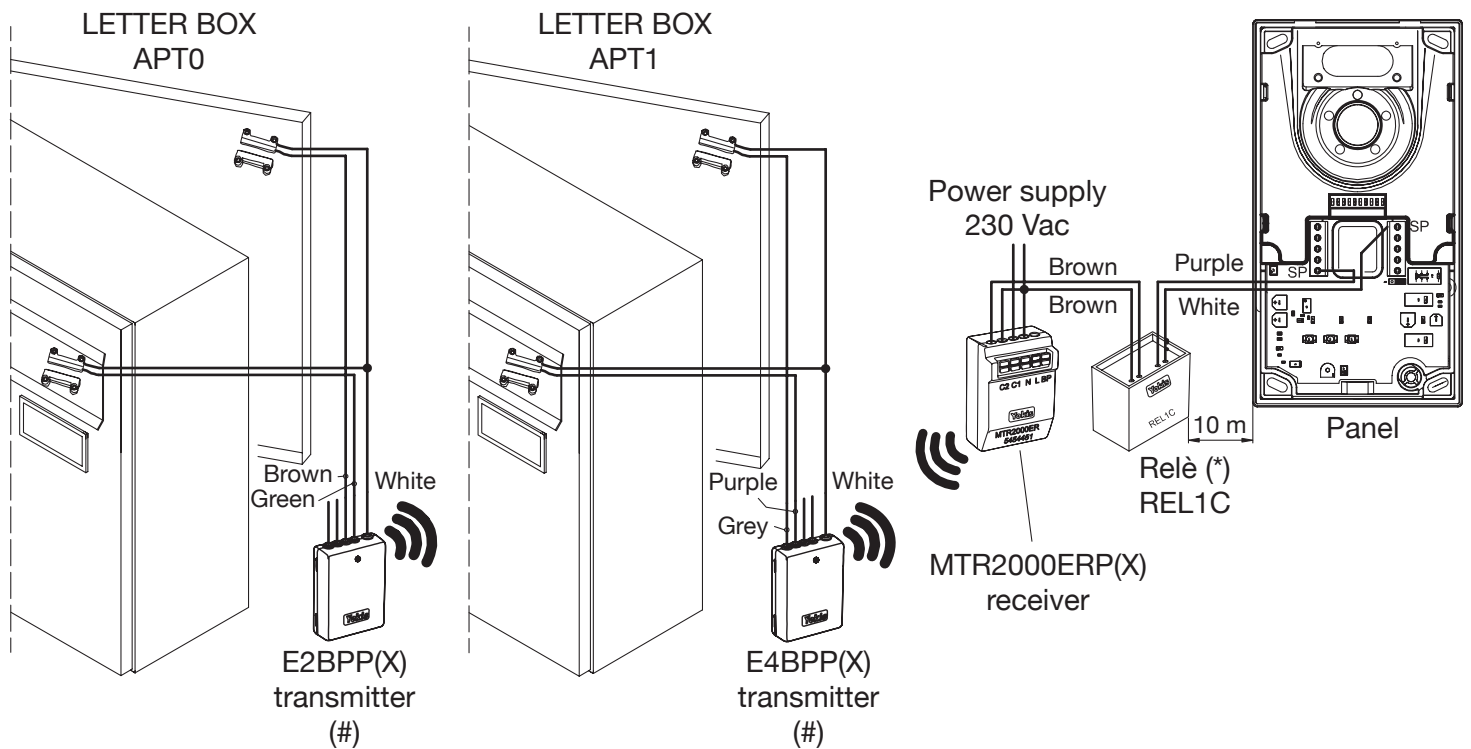

(#) A single E4BPP(X) transmitter can be used if the two letterboxes are close (distance of less than 10 m)

(*) WARNING. THE USE OF THE REL1C RELAY IS MANDATORY. IT ENSURES THE INSULATION BETWEEN THE LOW WORKING VOLTAGE OF THE KIT AND THE 230Vac VOLTAGE AT WHICH THE MTR2000ERP(X) RELAY IS POWERED. FAILURE TO USE THE REL1C RELAY WILL INVALIDATE ALL WARRANTIES.

Configure the devices as shown in the next chapter.

CONFIGURATION

The configuration requires three steps:

STEP 1: CONNECT THE TRANSMITTER TO THE RECEIVER

Using a temporary button in parallel to one of the magnetic contacts, press the button on the transmitter **E5** five times in rapid sequence.

Then, while the LED is blinking, press "Connect" on the receiver **R1**.

STEP 2: SET LETTERBOX MODE ON TRANSMITTER

On the transmitter, press rapidly 10 times (Configuration Menu **M**) and check that the LED starts flashing. Press rapidly 32 times (**32**) and check that the LED confirms at the end by flashing twice. At this point, the transmitter is locked in LETTERBOX mode⁽¹¹⁾.

STEP 3: SETTING LETTERBOX MODE ON THE KIT PANEL

Set dip-switch 1 in the ON position.

In this way, the LETTERBOX is enabled and the door open detection alarm function is disabled; the two functions are mutually exclusive.

THERMOSTAT SETTING

With the thermostat function the video door phone can be used to control the boiler.

Normally, the thermostat function is not active.

Proceed as follows to set it:

- Connect an external temperature sensor (e.g. Ref. 1430/50) to the video door phone.
- Define the connection to the boiler, which can be:
 - wireless, using a pair of ‘home automation buttons’ and a Yokis MTR2000ERP module,
 - wired (using Contact 2, suitably decoupled).
- Activate the function.

CONNECTING THE TEMPERATURE SENSOR

The temperature sensor should be connected to the appropriate connector on the back of the video door phone using the wire supplied as standard with the video door phone.

The maximum distance between the sensor and the video door phone is equal to 1m.

WIRELESS CONNECTION OF THE THERMOSTAT TO THE BOILER

Position Yokis MTR2000ERP relay near the boiler.

Choose two home automation buttons which will be used exclusively for controlling the relay connected to the boiler.

The two chosen buttons **MUST BE ADJACENT**: e.g. 1, 2 or 2, 3 or 3, 4, and so forth up to 7, 8.

Connect the two buttons to the MTR2000ERP relay in wireless mode, defining the ON function to the first button and the OFF function to the second button (e.g.: 7= ON; 8=OFF).

WIRED CONNECTION OF THE THERMOSTAT TO THE BOILER

A wired connection (appropriately decoupled) can be used as an alternative to the wireless connection.

Open the Contact setup menu (see the respective paragraph) and set Contact 2 to the thermostat function.

(11) In LETTERBOX mode, the transmitter no longer accepts any controls, even reset. Exit LETTERBOX mode to reactivate the transmitter to receive controls.

The procedure to close LETTERBOX mode on the transmitter is intentionally complicated to prevent it from being inadvertently triggered by the knocking the letterbox flaps and doors. The procedure is the following: generate 10 rapid presses on any one of the inputs of the transmitter. At this point, the LED of the transmitter will flash four times, but not consecutive: the flashes will be spaced apart in a random manner. Press rapidly at each flash.

Only if the corresponding rapid presses are performed at the four flashes will the transmitter exit LETTERBOX mode. It is indicated by a rapid flashing.

ENDING CONFIGURATION

In the 'Configuration' menu which can be opened using the  icon on the top right, select the 'Installer' menu, type in the password ('1937') and select 'Thermostat Settings'.

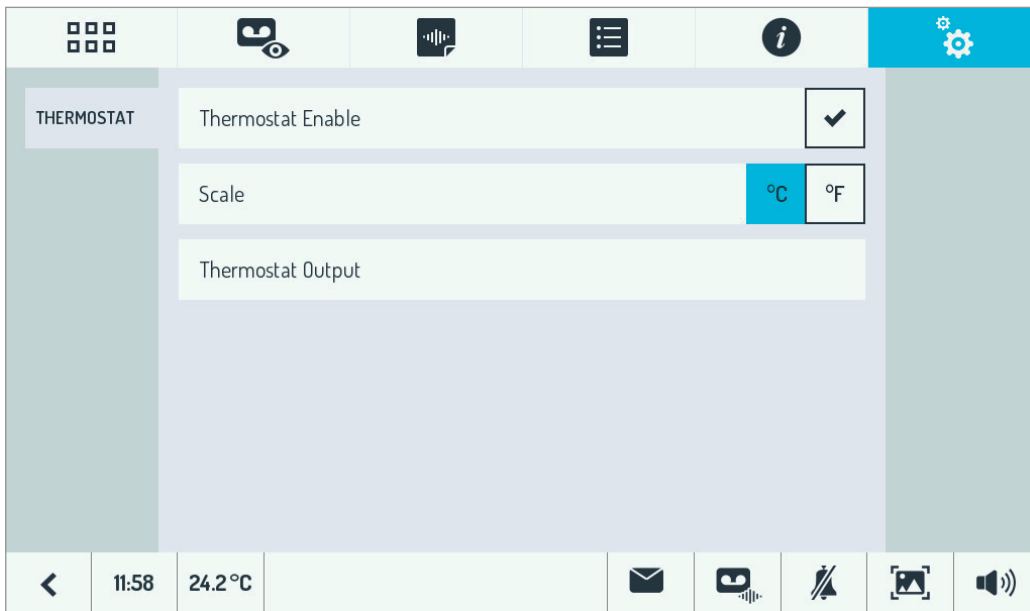

When the thermostat is activated, two other lines appear which can be used to:

- Set the unit of measurement (°C or °F).
- Define the output of the thermostat to the boiler.

The output of the thermostat to the boiler can be defined as follows:

- IF Contact 2 was assigned to the 'Thermostat' function, then 'Contact 2' will automatically appear on this line and there will be nothing to do: the choice is already fixed.
- IF instead you want to control the boiler in wireless mode, the line will be initially empty. Tap on it to open the following page:

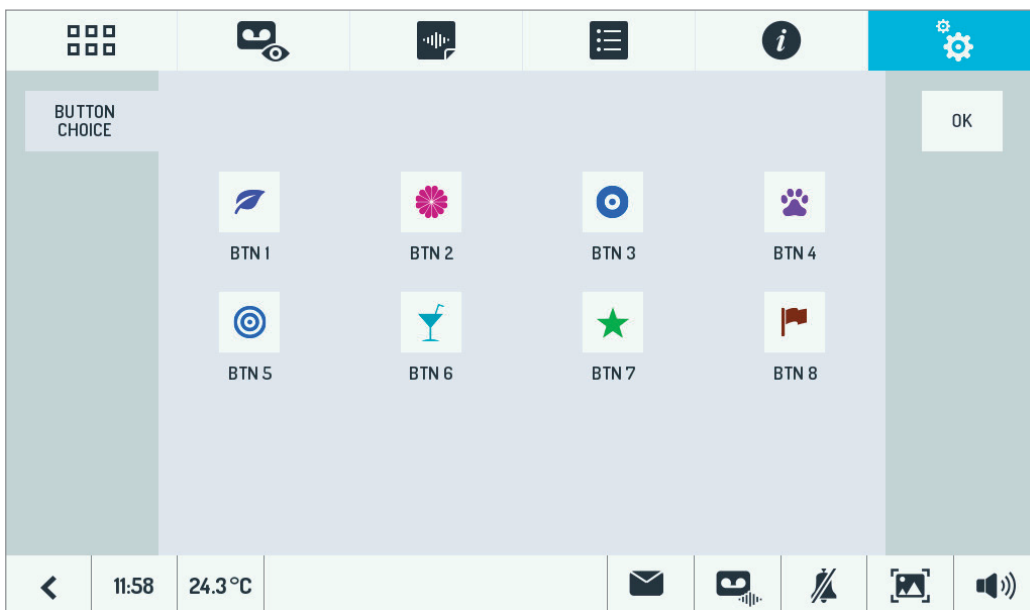

Tap on the ON button referred to the pair of buttons already previously configured to control the MTR2000ER relay. For example, tap on button 7. The adjacent OFF button will be automatically selected:

Tap on OK to confirm.

The indication of the two selected buttons will now appear on the line⁽¹²⁾⁽¹³⁾:

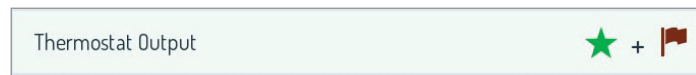

OFFICE WITH ATTACHED HOME SETTING

In some situations, the user may have an office downstairs and live upstairs. In these cases, you will need two separate call buttons for:

- the office
- the home

The user must use with a two-family kit Ref. 1723/72, which has a panel with two buttons and video door phones, one which will be installed one in the office and one in the home.

In the standard configuration of the kit, one button will exclusively call the office and the other will exclusively call the home. The intercom function between the two will be obviously available.

However, the following function is often required.

When a visitor presses the office button, both the video door phones ring, but an indication appears indicating which of the two buttons was pressed: i.e. the office one or the home one.

In this way:

- Calls to the office can be answered from the office
- Calls to the family can be answered from the family apartment
- When the office is closed, the user can still receive calls to the office from the home (this is useful in the case of doctor's offices) and choose whether to reply from home or no.

Importantly, the kit provides the possibility of controlling two doors (in different manner) and so button  can be programmed to open the office door (by doing so, you can use the automatic door opener function during opening hours).

Button , instead, will open the door to the private apartment (the control relay must be appropriately decoupled).

To use this mode of operation, you must:

- on the panel:
 - move dip-switch 6 to the OFF position
 - move dip-switch 4 to the ON position
- on the video door phone intended for installation in the home 1 (with dip-switch 1 in the ON position):
 - move dip-switch 1 to the OFF position
 - move dip-switch 3 to the ON position
 - move dip-switch 4 to the OFF position

At this point:

When a call is made using the upper button, both video door phones will ring and the message will appear:

'PANEL 1: #0'

(12) *NOTE: Once having associated a pair of home automation buttons to the Thermostat function, they will no longer be editable within the home automation settings (they will be greyed out). So, it is necessary to configure the buttons for the ON and OFF functions BEFORE configuring the buttons for the ON and OFF functions, as described in the previous paragraph and THEN assigning them to the Thermostat function.*

(13) *If you want to release the buttons matched to the thermostat, simply reopen the same page and tap the button to ON, then confirm with OK.*

when a call is made using the lower button, both video door phones will ring and the message will appear:
'PANEL 1: #1'

Remember that the writing with the name of the panel (default 'PANEL') can be customised by the installer in the 'Configuration' menu ('CCTV' item).

 Two more video door phones can be added to the installation. The dip-switch configuration mentioned above must be repeated on all of them, but the two dip-switches in position 2 and 3 must be respectively positioned in ON, OFF and ON, ON.

 A second panel can also be added to the installation ⁽¹⁴⁾.

AUTOMATIC DOOR OPENER SETTING

For securing reasons, some users may not want to activate the automatic door opener function. The installer may inhibit the respective key using the 'Configuration' menu. In the 'Configuration' menu which can be opened using the  icon on the top right, select the 'Installer' menu, type in the password ('1937'), tap on the arrow button on the bottom and then select 'Auto Door Opening Enable'.

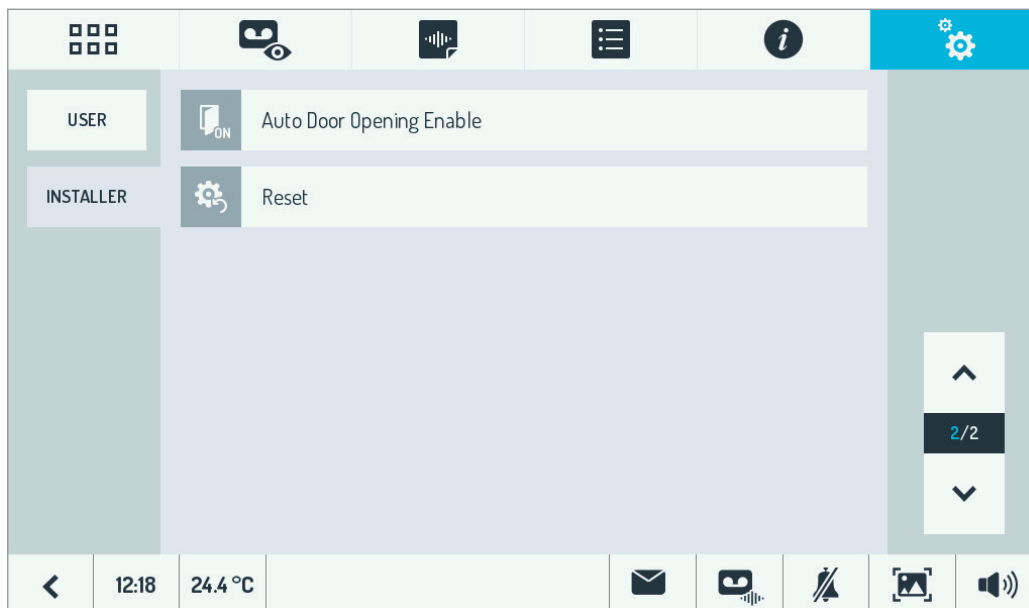

(14) There are three possibilities:

- you can purchase a panel with two buttons (Ref. 1723/12) and move dip-switch 6 to OFF and dip-switch 4 to ON. The following will appear according to which button is pressed (upper or lower) "PANEL 2:"
- you can purchase a panel with two buttons (Ref. 1723/12) and moves dip-switch 6 to the OFF position leaving the dip-switch 4 in the OFF position, so both buttons will call the room which receives calls from the upper button of the main panel. The following will always only appear: "PANEL 2"
- you can purchase a panel with two buttons (Ref. 1723/11) and so the call from this button will be always and only addressed to the local that receives calls from the button at the top of the main panel: "PANEL 2"

Remove the tick from the 'Auto Door Opening' option.



In this way, the





button will no longer be visible on the Home Page.

TEST

VIDEO DOOR PHONE CALL TEST

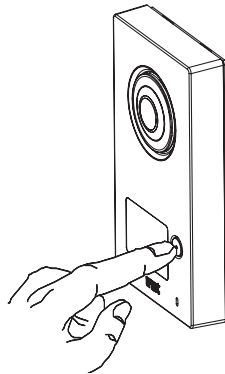
Make a video door phone call by pressing the Call button:



The icon  lights up to indicate that the call was sent. The following will appear on the video door phones in the system:





Also without answering, the door can be opened by using either:

– button  lights up green to be easily located

– the  button.

When the door opens, the icon  will light up on the panel.



It is also possible to switch on the stairs or garden light using button  or to open the garage door using the

button . Alternatively, the call can be rejected by pressing the button .

To answer, tap on either:

– the lower button , lit red

– the  button.

When the call is answered, button  turns green and the icon  will light up on the panel to invite the visitor to start speaking.

To end the conversation, tap on either:

– the green button 

– the  button.

After a call (before starting the conversation or during the conversation itself) is also possible:

- To change the image format from 4:3 to 16:9 or vice versa To do this, tap on the icon  . When 16:9 format is selected, the camera will frame the upper part of the scene. The frame can be moved by sliding the image with your finger:



 The picture format in use is stored at the end of the call. Later calls will appear using the last chosen video format.

- To cycle the other cameras in the system using the side arrows  .

 You must return to the camera of the panel to answer.

- To record a video clip of the visitor by tapping the Record button  .

- Once the recording starts the button becomes  . The counter indicates the progress of recording.

The recording may be ended by pressing the button again or when the maximum recording time is reached.

- Adjust the video brightness, contrast and saturation by tapping on the icon  :

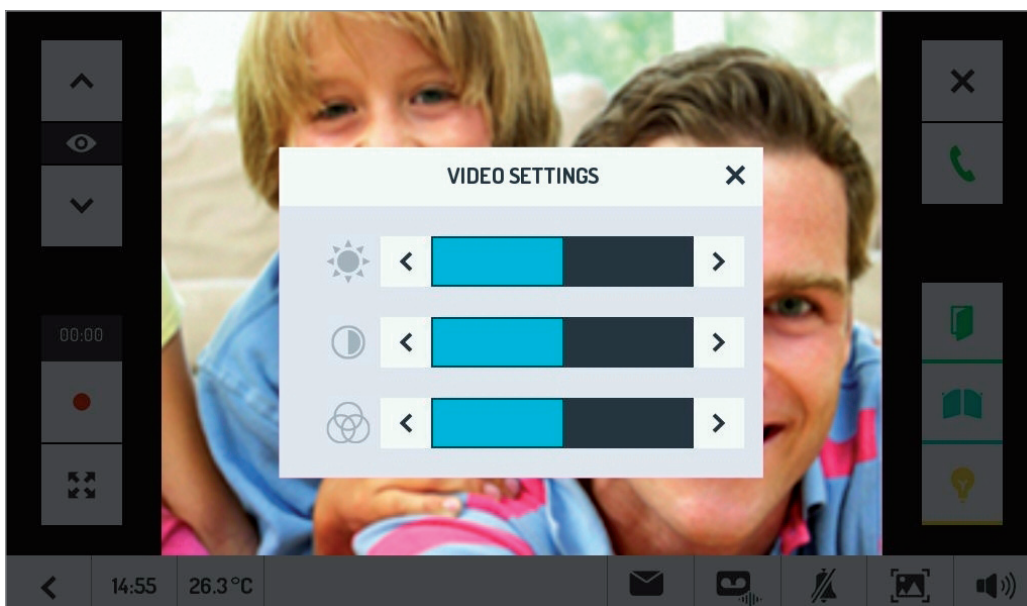

- Adjust the speaker sound intensity (and if you wish enable/disable the feedback click when the display is

touched) by tapping on the icon  :

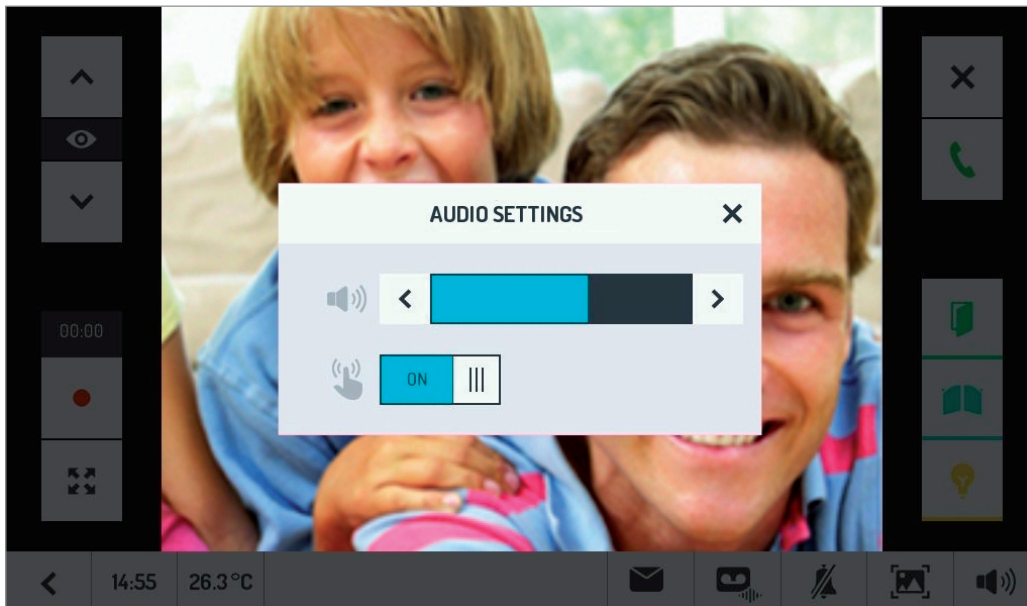

Finally, during conversation, you can mute/unmute the microphone so that the visitor cannot hear you by pressing the button  .

CAMERA CONTROL TEST

Switch on the video door phone by tapping on the screen or the button  .

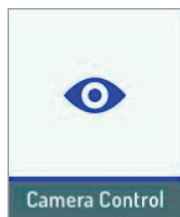

Tap on the camera control button:



The video door phone will show the image from the panel camera, also providing the possibility to open the door or start a conversation:



Using the two arrows on the top left, it is possible to cycle all cameras present.

If a cycle time has been defined, the icon  will have a blue background:  . In this case, the image below

will automatically appear on the camera after the programmed cycle time.

The user can disable or re-enable cyclic view display by tapping the icon  at any time.

Tap on the icon  to start recording a video clip.

If cyclic transition between cameras is enabled, video clip recording is considered a priority. Therefore, the switch to the next camera can only happen at the end of the video clip recording, whereby allowing the user to record everything they want.

ALARM FUNCTION TEST

ACTIVATION PROCEDURE

The alarm function can be activated if at least one sensor is connected.

Switch on the video door phone by tapping on the screen or the button .

Activate the alarm, by tapping on the icon  and then the respective button.

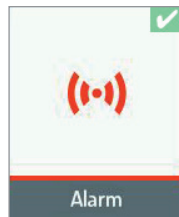



A tick will appear next to the button

The alarm LED in the top right  flashes during the possible output time (any alarms during Exit Time will have no effect) and turns green fixed to its end, to indicate successful activation. The video door phone display will switch off automatically 60 seconds after the last button has been pressed.

ALARM

Simulate an alarm by changing the state of a Normally Closed sensor.

The following occurs on the master video door phone:

- If you have set an entry time, the alarm LED in the top right  will flash green for all this time.
- At the end of the entry time, the alarm LED on the top right  you will turn solid red.
- If enabled, an audible warning is emitted for 60 seconds.
- If enabled, a video recording of set time (max. 50s) starts after the set time delay (max. 30s).
- If video clip recording enabled, the images filmed by the camera set are displayed. Alternatively, a fixed image will appear.

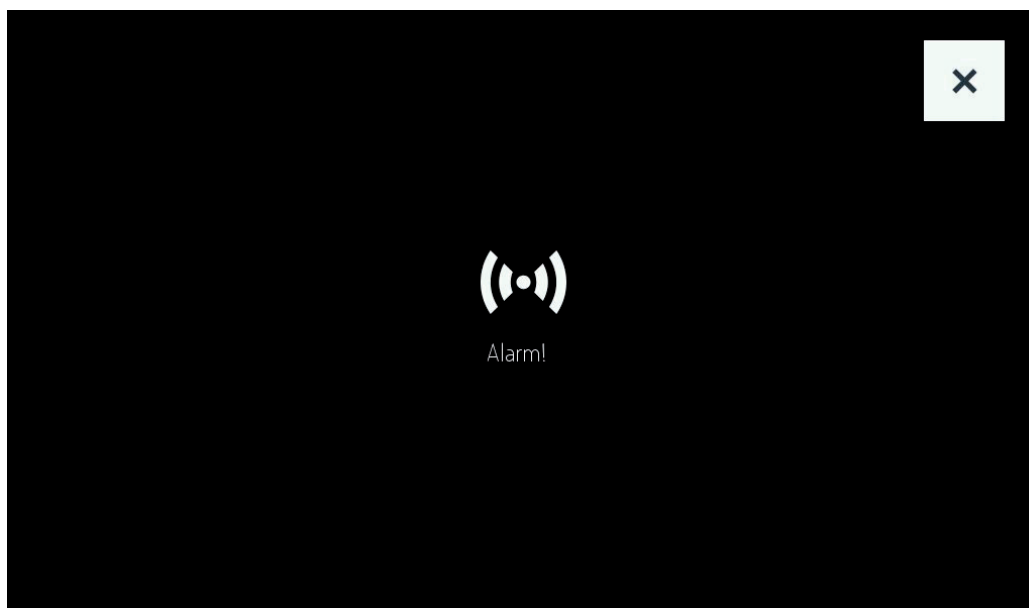

Tap on the icon  to silence the alarm. This will not deactivate the system. During the alarm, other warning may be sent according to the settings.

It is possible to:

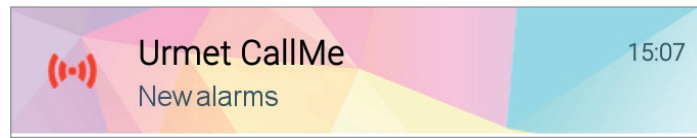

- Send a notification to an external siren.
- Activate a specific home automation scenario (e.g. the garden lights).
- Send the remote alarm signal, by means of a call sending device (the CallMe app, in this case). This indication generates a push notification on the smartphone, of the following type:



 **The alarm sensor can be closed and reopened, thereby simulating a second alarm. However, this second simulation must be performed AT LEAST 90 seconds after the first simulation of an alarm. Whenever the alarm sensor is energised, the video door phone ignores any after alarms for 90 seconds.**

WARNING. The alarm masking time on call sending device is currently longer, equal to 10 minutes ⁽¹⁵⁾.

PAST ALARM SIGNALLING (ALARM MEMORY)

The past alarm memory (one or more alarms) is signalled to the user upon return home by the Alarm LED flashing red  (the video memory LED  will also flashing green, if a video clip was recorded).

DISARMING

The alarm is typically disarmed during the entry time⁽¹⁶⁾, by tapping on the icon

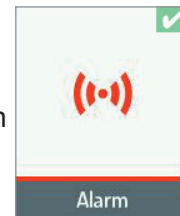

to clear the tick.

HOW TO BROWSE VIDEO CLIPS

All recorded video clips (automatically in case of alarm or voice mail, or manually in case of recording during a call or auto-on function) are listed in the video clips section which can be accessed by pressing the button





. The number next to the icon indicates the number of automatically recorded video clips (video door phone voice mail and alarm) not yet seen.

The recordings to be viewed are green, the ones which have already been black.



Simply tap on the name of a video clip to see it.

(15) So, if the generation of multiple alarms in close sequence is simulated during the test phase, e.g. 2 minutes from one another, these will all be stored in the alarm history of the video door phone, but only the first one will appear in the alarm history of smartphone. This masking time will be reduced to just 90 seconds on the new version of the call sending device, so as to align the two behaviours.

(16) Note that during the entry time:

- if there was no previous alarm, the LED  flashes green
- If there was a previous alarm, the LED  flashes alternately green and red (alarm memory).



The icon on the left can be used to quickly recognise the recording type:  indicates a video clip saved in the event of alarm,  indicates a video clip recorded from the panel using the video door phone function or manually during a call, the icon  indicates a video clip recorded by additional camera.

The video clip name always comprises:

- the number of the camera which recorded it (1 to 6)
- the name of the camera (customisable during installation)
- the date
- the time
- suffix ‘_AL’ if the registration was the result of an alarm

HOW TO BROWSE THE ALARM HISTORY

All alarms are stored on the master video door phone and can be accessed by tapping the icon  and then the ‘Alarms’ tab. A list of the most recent alarms detected will appear, with indication of date and time:

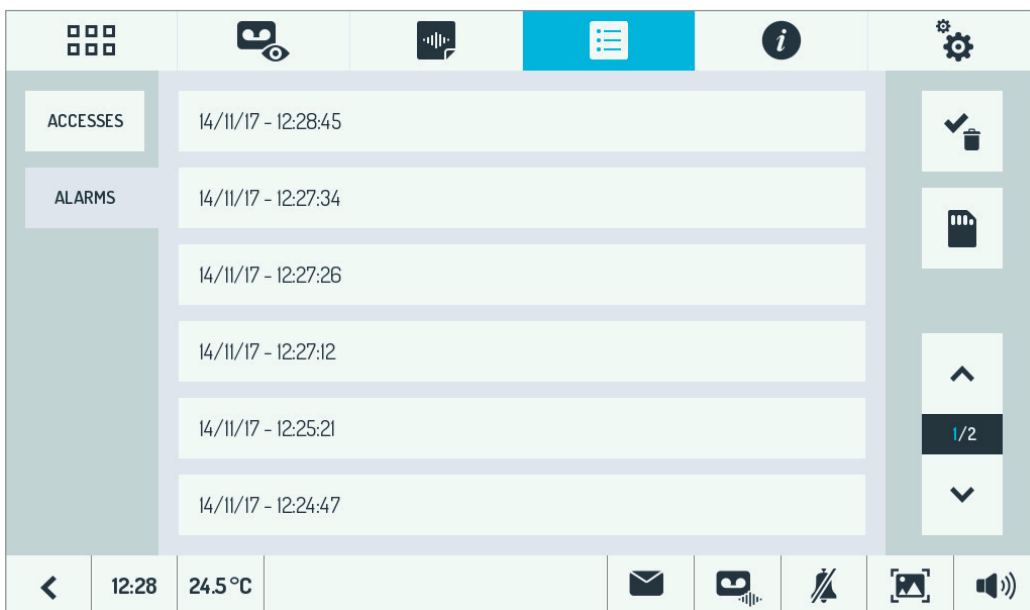

The alarm history can be browsed on CallMe app following a similar method⁽¹⁷⁾ :

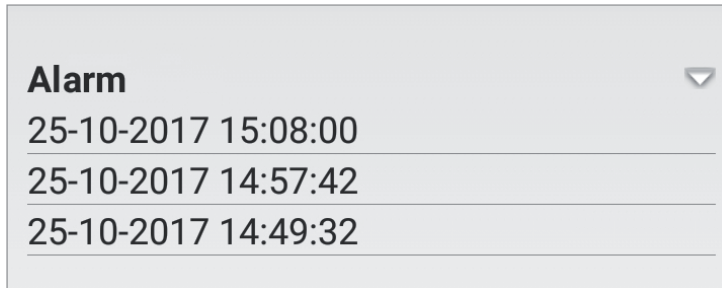



WARNING. Since the call sending device, after sending an alarm notification, masks any other sending for 10 minutes, the alarm history may contain a fewer alarms than those present on the master video door phone.

HOW TO SAVE THE ALARM HISTORY

The alarm history can be saved on a microSD card.

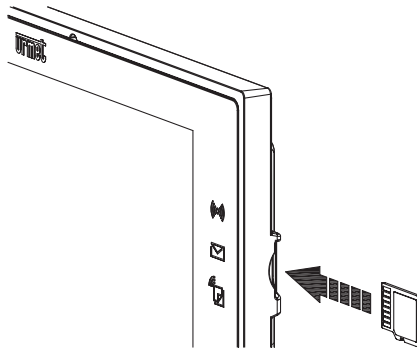
Switch off the display of the master video door phone using the middle button and insert a microSD card⁽¹⁸⁾ :

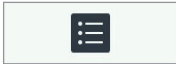

Switch the video door phone back on and first tap the icon  and then the 'Alarms' tab. A list of the most recent detected alarms will appear with the icon showing the symbol indicating that it was saved to microSD card on the right  :

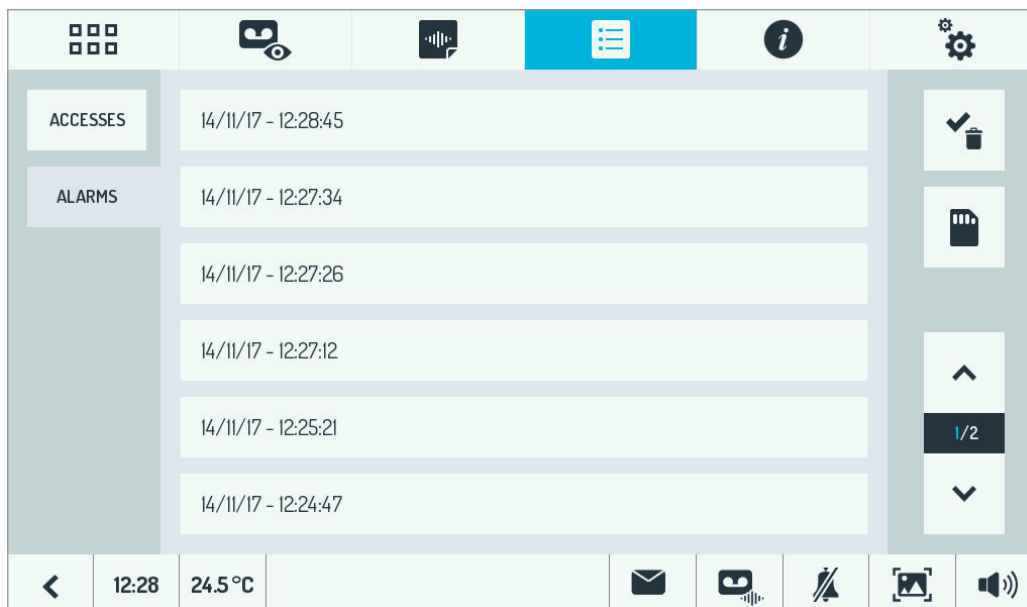

Tap on the icon with the symbol of the microSD card on the right: saving will be started. While saving, the icon turns blue for a usually very short time.

WARNING. DO NOT REMOVE THE microSD CARD WHEN THE ICON IS BLUE.

(17) The title of this page can be customised on call sending device, using the CallMe app.

(18) Use a standard microSD and not a microSDHC card.

After writing, the icon turns black on white background again: the microSD card can be removed.
 The alarm history will be stored in a folder on the microSD card named 'LOGS'.
 If the folder does not exist, it will be created automatically before writing the file.
 This is a text file which can be viewed on a PC with any text editor.

LETTERBOX FUNCTION TEST



- Put an envelope into letterbox (simply simulate the insertion by opening the flap).
- Check that on the master video door phone in the apartment, the mail present LED  turns green and flashes.
- Simulate mail collection from the letterbox by opening the rear collection door and check that the LED goes out.

WARNING. If you want to repeat the test on the same letterbox, wait for 10 seconds (after closing of the rear collection door) before repeating it.

AUTOMATIC DOOR OPENER TEST



Switch on the video door phone by tapping on the screen or the button .

Enable the automatic door opener function, tapping the icon  first and then the button .

After enabling, a tick will appear next to the button  and the LED on the bottom right  will flash

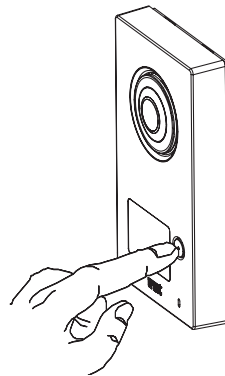
Making a call:



The call will be sent and will be opened the door at the same time: on the panel, the call icon  and door opener icon  will light up:

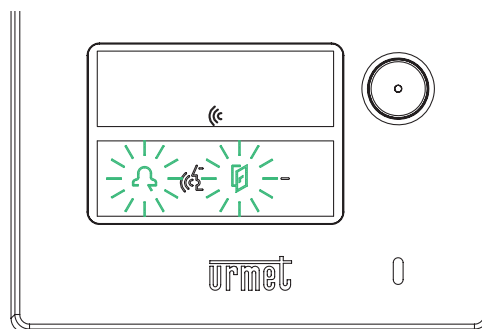

 To disable the automatic door opener function, proceed as for activating it.

OFFICE WITH ATTACHED HOME SETTING

Make a video door phone call by pressing the upper Call button:

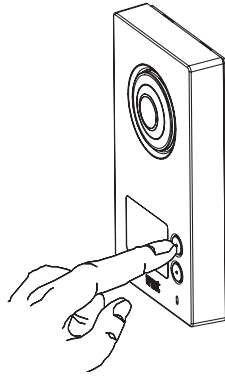

The icon  lights up to indicate that the call was sent.

The following appears on the video door phones in the home and in the office:



All the call related functions will be available in standard configuration. (See the VIDEO DOOR PHONE CALL TEST section).

Make a video door phone call by pressing the lower Call button:

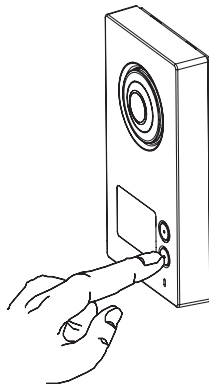

The icon  lights up to indicate that the call was sent.

The following appears on the video door phones in the home and in the office:





All the call related functions will be available in standard configuration. See the VIDEO DOOR PHONE CALL TEST section.

UPDATING THE VIDEO DOOR PHONE SOFTWARE

Proceed as follows to update the software (SW) of the device:

1. Go to
Download\Software\Technical software\Communication 1723/71\-/72 video door phone Kit
www.urmet.com site after having signed up (free registration);
2. Download the update file **1723_vX.Y.Z-W_fup.zip** and copy it to the root directory of your microSD card;

 *The file name **vX.Y.Z-W** indicates the SW version.*

3. Insert the card into the video door phone;
4. Switch on the display, if it is off, by pressing the central button ,
5. Hold the button  pressed until the video door phone reboots.
6. Wait for the update to end (the operation may take as long as 5 minutes);
7. Success of the operation is confirmed by the presence of a green stripe on the video door phone screen and after a few seconds by a subsequent restarting of the device.

 *If red stripe appears on the video door phone, repeat the procedure from step 5 because the update was not successful. The video door phone will continue to operate with the previous software version.*

8. When the video door phone is active again, open the page  to check verify that the software version which appears on the screen has the same code as that shown in the name of the file on the microSD card.
9. Finally, remove the card. The update procedure is done.

ACCESS CONTROL

The kit comprises 5 transponder keys and 2 chip tags for electric lock activation.

The chip tag is the sensor contained inside the keys and can be attached to various objects of daily use (keyholder, cell phone, watch. etc.).

To open the door, move a key or the object to which the chip tag has been attached close to the name tags area of the call station (the correct point is indicated with (()) as shown to the side.

 *The keys and the chip tag must be associated to the call station as indicated in paragraph "Key memorisation procedure".*

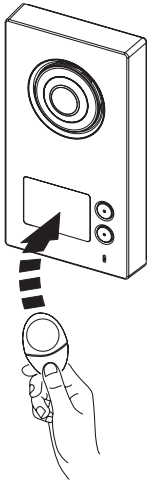

If a valid key is presented, the call station emits a confirmation beep and activates the electric lock. If an invalid key is presented, the call station emits a long beep and the electric lock is not activated.

KEY MEMORISATION PROCEDURE

Only keys memorised can activate the electric lock connected to the call station. To memorise the keys:

1. Move the master key close to the call station;
2. The call station emits a confirmation beep;
3. Move the key or chip tag to be programmed close to the call station;
4. The call station emits two beeps to indicate that programming has been completed;
5. Repeat operations 3 and 4 for all the keys to be programmed;

 *Up to 21 keys can be programmed. If an attempt is made to program a twenty-second key, the call station emits only one beep (instead of 2) to indicate that programming has not been performed.*

6. Move the Master key close to the call station;
7. The call station emits three beeps to indicate exit from programming. In case of forgetfulness, the exit programming mode will be done automatically after 30 seconds.

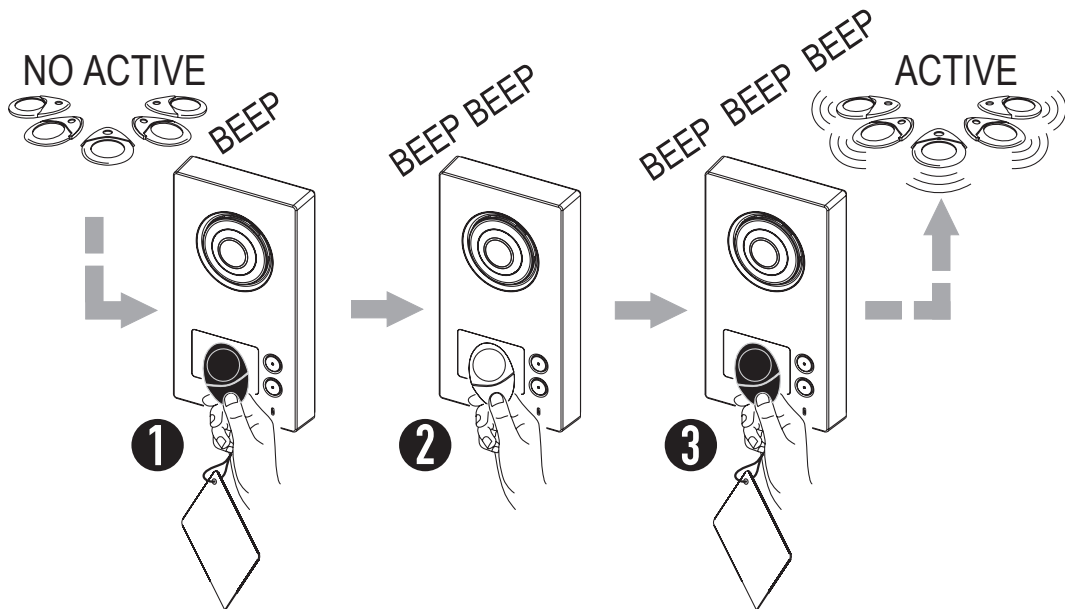

KEY CANCELLATION PROCEDURE

To cancel the keys programmed:

1. Move the Master key close to the call station.
2. The call station emits a confirmation beep.
3. Hold the Master key in front of icon ((for at least 5 seconds.
4. The call station emits a long confirmation beep. Remove the key immediately.

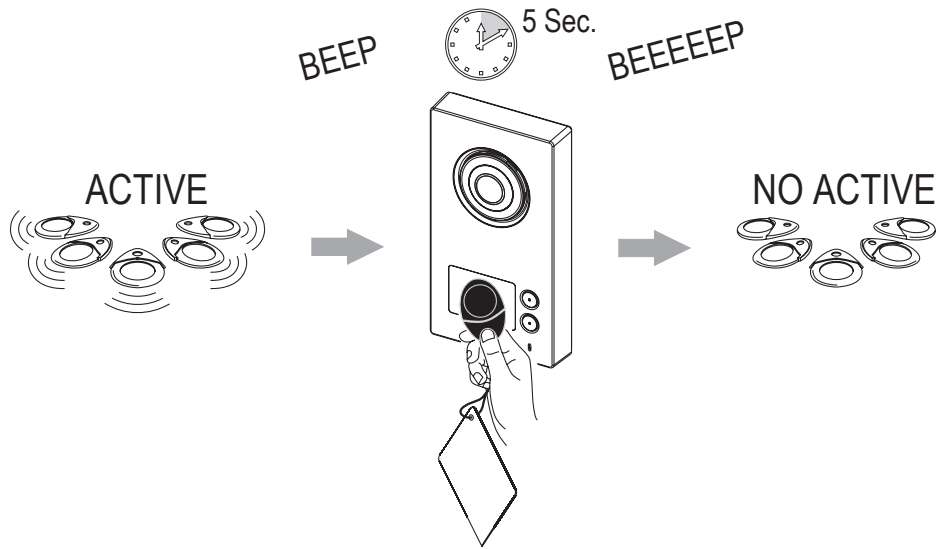

 **In this way, all the keys saved up to this moment will be cancelled.**

ANNEXES

ANNEX A

How to configure Yokis buttons from the video door phone (without using the Yokis PRO app).

In this operating mode, you can configure the Yokis buttons (virtual) directly from the video door phone. The advantage is that a wizard interface can be used to simplify operations: the video door phone automatically manages the pulses needed to configure the Yokis buttons.

During this step, you will need to press the 'Connect' button on several receivers.

Each Yokis button can be configured to control a single activation module or multiple modules (Scenario or Centralisation Scenario) either directly or in radio bus mode.

See the Yokis 'Radio Quick Installation Guide' for more information on the available options.

On the Home Page of the video door phone, press the 'Configuration' icon , then select the 'Installer' tab and enter the password ('1937'). The following will appear:



Select the 'Home Automation' menu.

You will be directed to the following page:

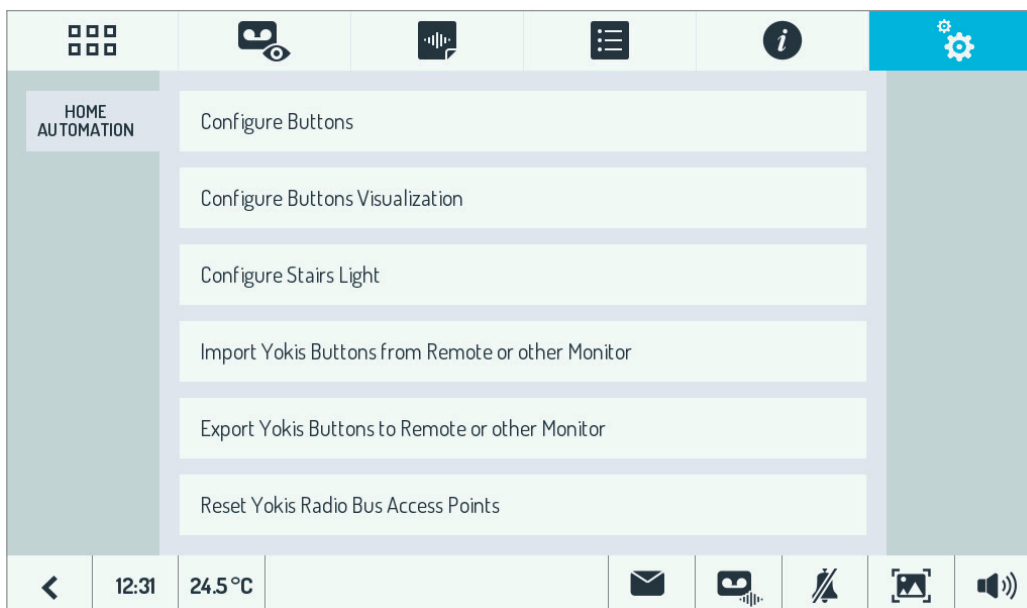

Select 'Configure Buttons' to go to the following page:

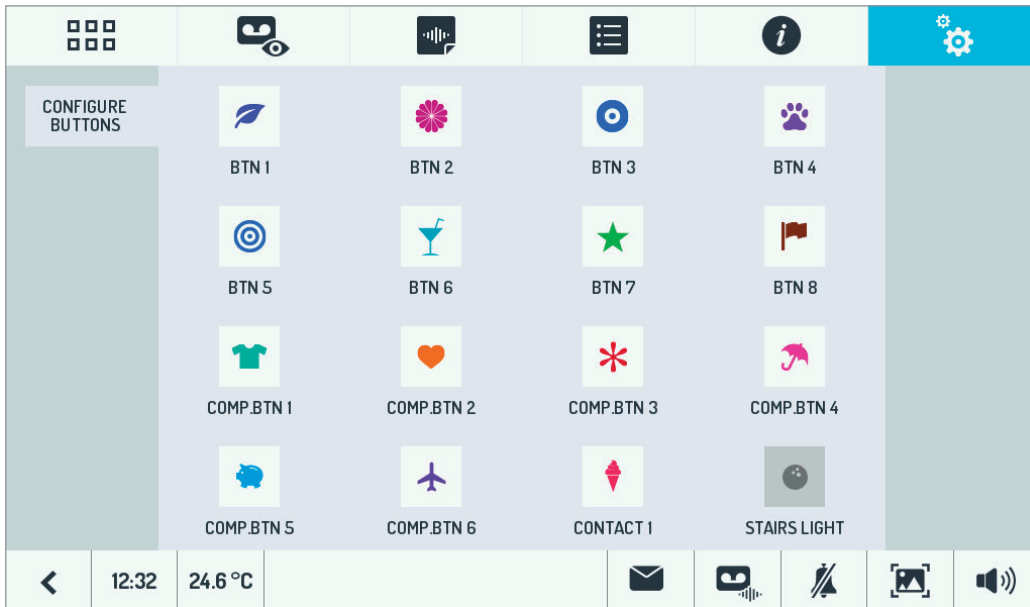

The Yokis buttons are the first 8 on top.

Tap on the Yokis button you want to configure.

Five items will appear:

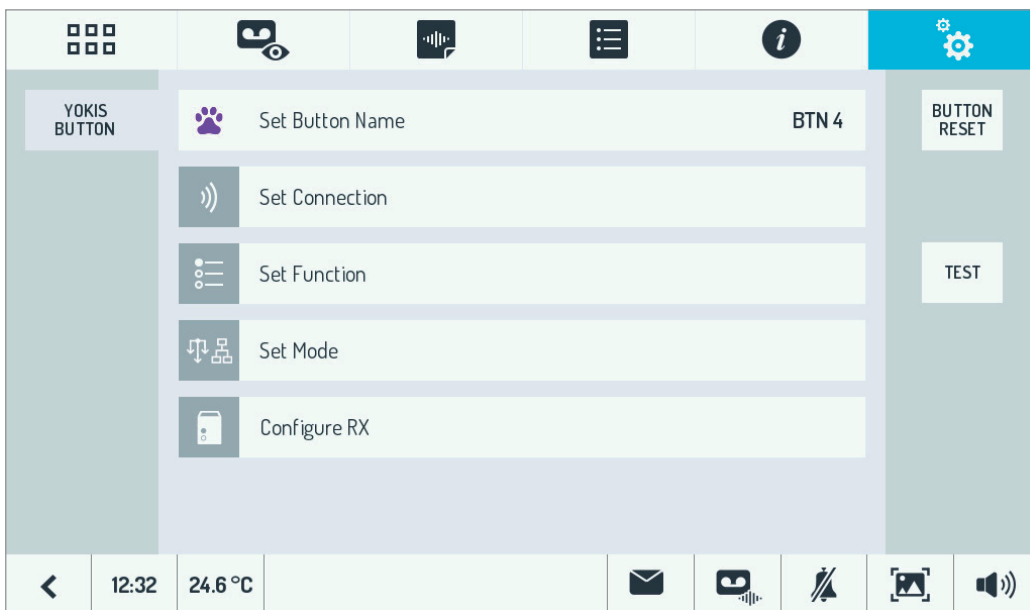

Select the first item, 'Set Button Name', to assign a mnemonic name to the button using the keyboard:

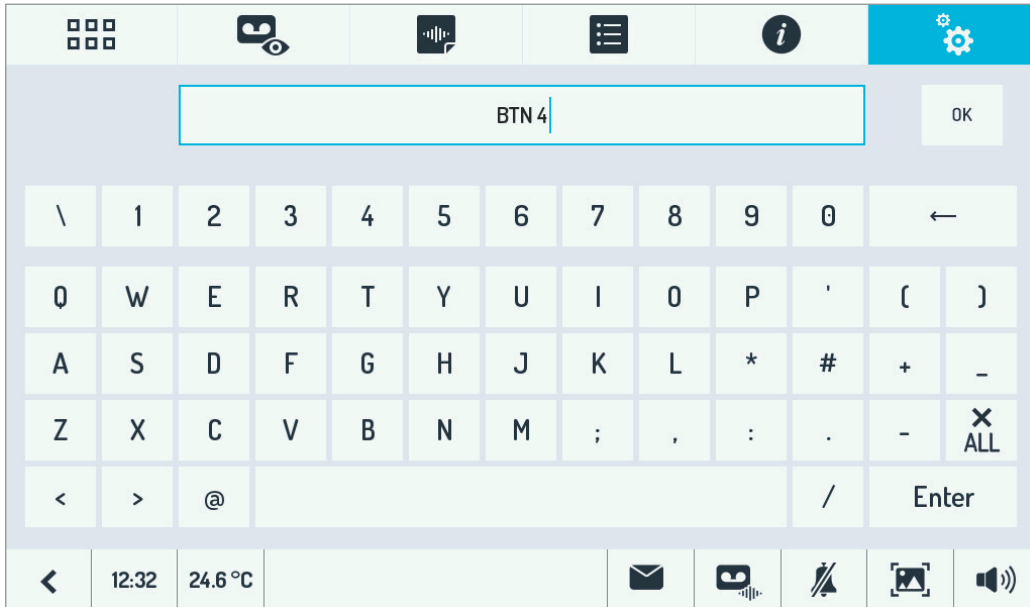

Select 'OK' to confirm.

Some background information may be useful before describing the remaining four items in detail.

The button configuration procedure is similar to that of the buttons of a Yokis eight-button remote control. The video door phone automatically sends the pulses needed for the configuration, without which the installer needing to remember the number of pulses required in the various cases (these are shown in the text for the sake of convenience of reading).

For example, if you choose to 'connect' a button to a receiver, the video door phone will send five short configuration presses.

The green LED on the video door phone  corresponds to the red LED of a Yokis remote control: the notification flashes can be seen on it. The expected number of flashes is shown on the display so the installer can check easily.

WARNING. **Some configurations may last a few seconds. Always wait for the notification flashes before moving to another.**

The following is present on the right side of the main page of the configuration of each button:

- a 'Test' button for immediately checking the behaviour of the button at the end of a configuration;
- a 'Reset' button for starting back from scratch by resetting the specific button (and only that button) like on a Yokis remote control. Intentionally, resetting the single button does not change its name.

It is always possible to go back to the upper level menu, by pressing the button  .

Now will be examine the four items which can be selected.



This opens a submenu for connecting the button to one or more receivers.

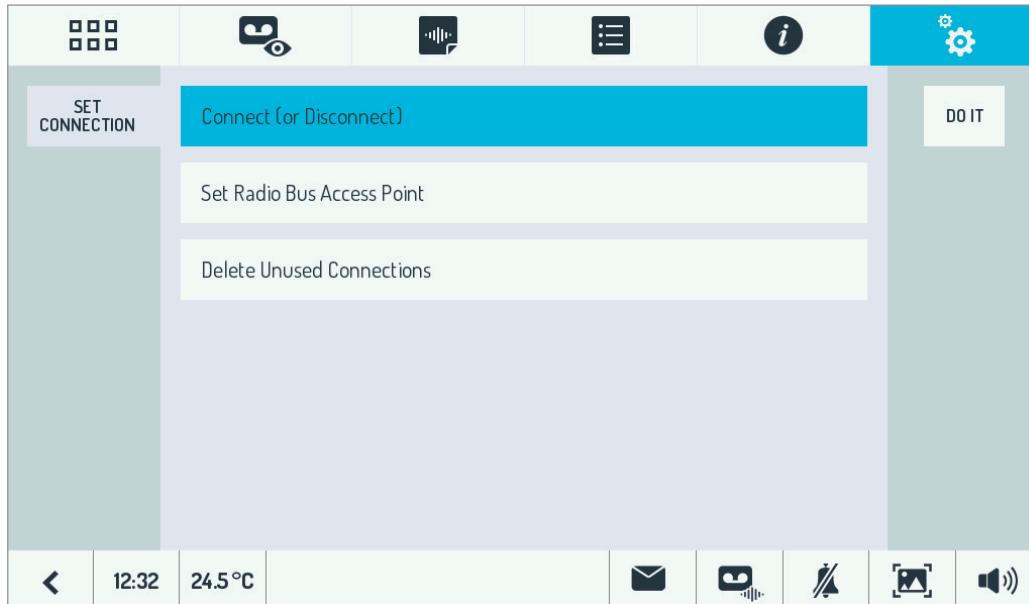

Connect (or Disconnect) **E5 R1**

This is used to logically 'connect' the button to a receiver.

In direct mode, one or more receivers, up to four can be connected (connecting a fifth receiver will replace the fourth one).

In Radio Bus mode, if only one is typically connected.

For more information, see the Yokis 'Radio Quick Installation Guide', para. 'A-1: Connecting a Transmitter to a receiver'.

The same button can be used to perform the 'disconnection' procedure:

par. 'A-3: Disconnecting a transmitter from a receiver'.

The other two menu items are used less frequently:

Set Radio Bus Access Point **E7 R1**

This is useful for controlling a specific remote receiver (or also more than one), positioned on Bus Radio.

For more information see 'E: Range Extension with Radio Bus' and 'E-1: Definition of an Access Point to the Radio Bus' of the Yokis 'Radio Quick Installation Guide'.

WARNING. In the event of a mistake, you cannot delete only the specific Access Points of a button. In this case, you will need to delete simultaneously all the access points of all buttons of the video door phone. To do this, use 'Delete transmitter access points', available on the upper menu **M 24**.

Delete Unused Connections

If the button controls a single receiver, this option may be useful to replace the receiver. Firstly connect the new receiver with Connect (or Disconnect) (see previous page). Then, use this menu item to delete the connection to the old receiver. Run **E21**.



One of four possible operating modes can be defined for the button:



- Toggle (lighting), Dim/Off (dimmer), Up/Stop/Down (shutters) **M 1**
- On (lighting), Up & Stop (shutters) **M 3**
- Off (lighting), Down & Stop (shutters) **M 4**
- Memory, Go to position (shutters) **M 2**

For more information, see the Yokis 'Radio Quick Installation Guide', para. 'G – Configurations of pushbutton functions'.

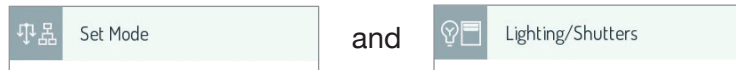

By default, the Yokis buttons operate in Direct Mode for controlling up to four receivers. On a video door phone, instead, is often useful to use the buttons in centralised mode, e.g. to have a button which closes all the shutters, another one which turns off all lights, etc.

You will need to use Radio Bus centralisation to do this.

We must first gather together the receivers to create a Radio Bus **R1 R1**, then 'connect' the button to the closest receiver, and finally define the centralised mode of the button and specify whether it must operate on all lights or on all shutters or both.

Select the 'Set Mode' icon to define the mode:

Radio Bus **M 6** or Direct Mode **M 5**.

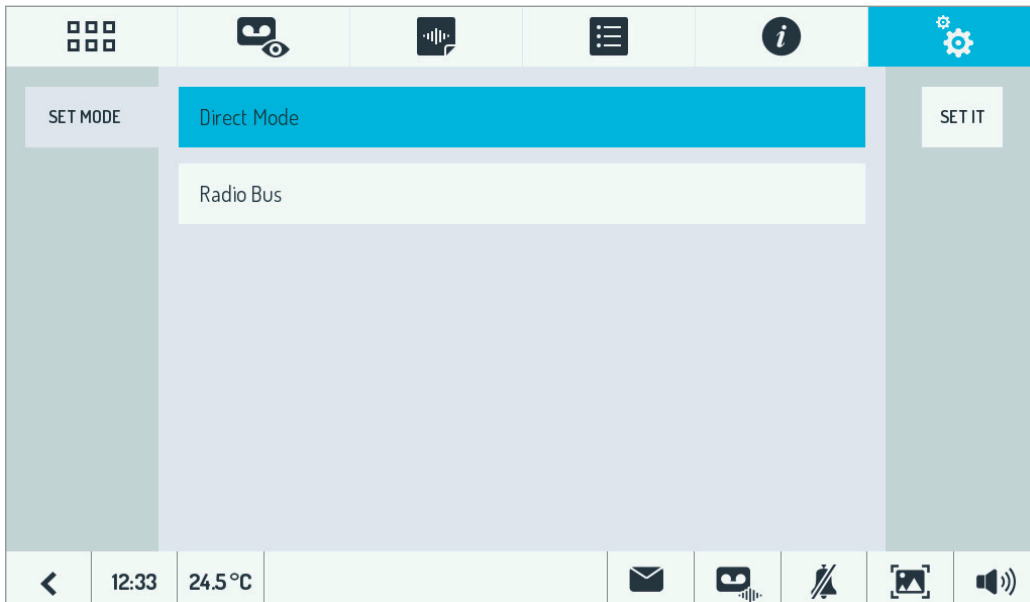

If Radio Bus mode is selected, a new 'Lighting/Shutters' menu item will appear for selecting whether the centralisation operates the lighting (default) or the shutters or both:

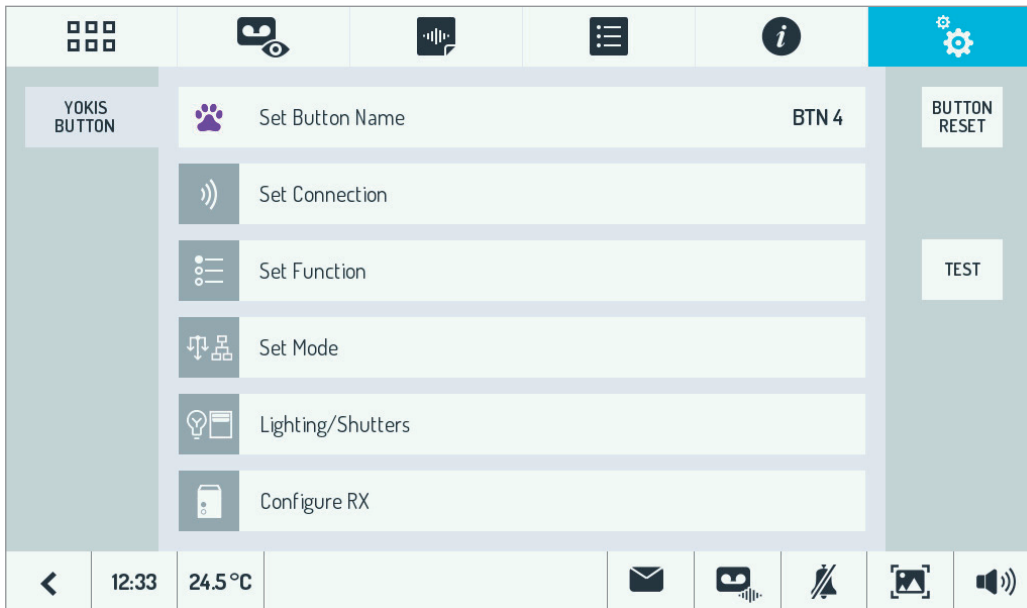

Select 'Lighting/Shutters' you can choose one of three options: Lights **M10** o Shutters **M11** or Lighting/Shutters **M20**.

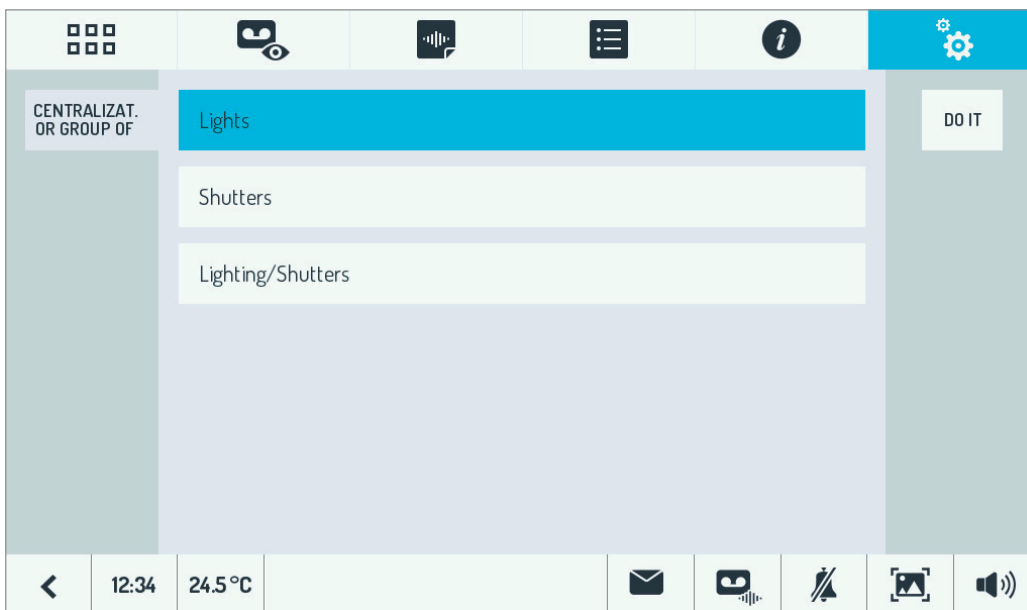

For more information, see the Yokis 'Radio Quick Installation Guide', para. 'F – Centralised control on Radio Bus'.

If you select 'Lighting/Shutters' centralisation, it is advisable to select the 'Off, Up & Stop' function (see previous paragraph) switch off the lights and closing the shutters ('Not Home' scenario).

If you wish to perform various functions at the same time, such as closing the shutters and switching off the lights ('Evening' Scenario), then you must:

- Configure a Centralised Button for the Lighting only with the desired function.
- Configure a Centralised Button for the Shutters only with the desired function.
- Configure a Composite Button to recall them both.



This option may be used only if a button was 'connected' to a single receiver module. In this case, the receiver can be configured with the respective pulse sequences.

Using the keyboard, define the number of pulses to be sent to the receiver module with the specific button, e.g. to configure the receiver timing. Then press 'Enter' and wait for the notification of the receiver, typically shown on the receiver (flashes or small movements).

See the manual of the single receiver modules for the possible controls.



For example, if a MTR2000ER relay module was 'connected' and you want its output to be timed for 15 minutes (e.g. to water the garden), then:

- Send 23 (**E23**) to unlock the configuration of the module and wait for 3 flashes on the receiver.
- Send 27 (**E27**) to switch the mode to timer mode and wait for 7 flashes on the receiver.
- Send 26 (**E26**) to configure the time in minutes and wait for 6 flashes on the receiver.
- Send 14 (**E14**) to set the timer to 15 minutes and wait for 4 flashes on the receiver.
- Send 21 (**E21**) to unlock the configuration of the module and wait for 1 flash on the receiver.

If instead you want the connected MTR2000ER module functions to work in pulse mode (i.e. for the module to generate a 0.5 second pulse whenever the button is pressed), e.g. to control the opening of a gate, then:

- Select the 'M' mode, by sending 10 pulses: **M**
- Then send 16 (**16**) to configure pulse mode and wait for 6 confirmation flashes on the LED of the video door phone

 **As previously mentioned, the receiver modules configuration only works if the button is connected to a single receiver module.**

ANNEX B

How to import Yokis Buttons from remote control (or other video door phone)

The procedure consists of three steps:

- 1) Use a Yokis eight-button remote control and configure the buttons. See the Yokis 'Radio Quick Installation Guide' for more information.
- 2) Check that all configured buttons work correctly.
- 3) Import the remote control in the video door phone as described.

WARNING. The importing procedure deletes the configuration of ALL 8 Yokis buttons on the video door phone, but not their labels.

On the Home Page of the video door phone, press the 'Configuration' icon  select the 'Installer' button, enter the password ('1937'), and then select the 'Home Automation' menu. You will be directed to the following page:

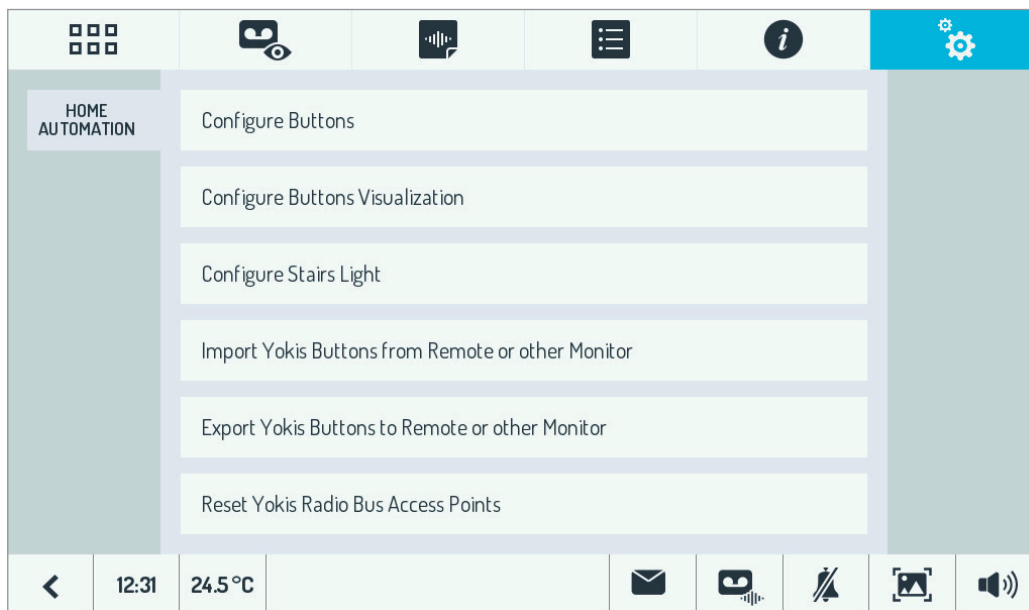

Select 'Import Yokis Buttons from Remote or other Monitor'.

A Wizard will open to guide the installer to the end of the import procedure: follow the indications of the Wizard. Follow the directions in the following diagram.

At the end of the import, for each button:

- Define the name.
- Check the correct operation of the imported button.

To do this, at the end of the Wizard select 'Configure Buttons'.

The screen showing all the buttons will appear:

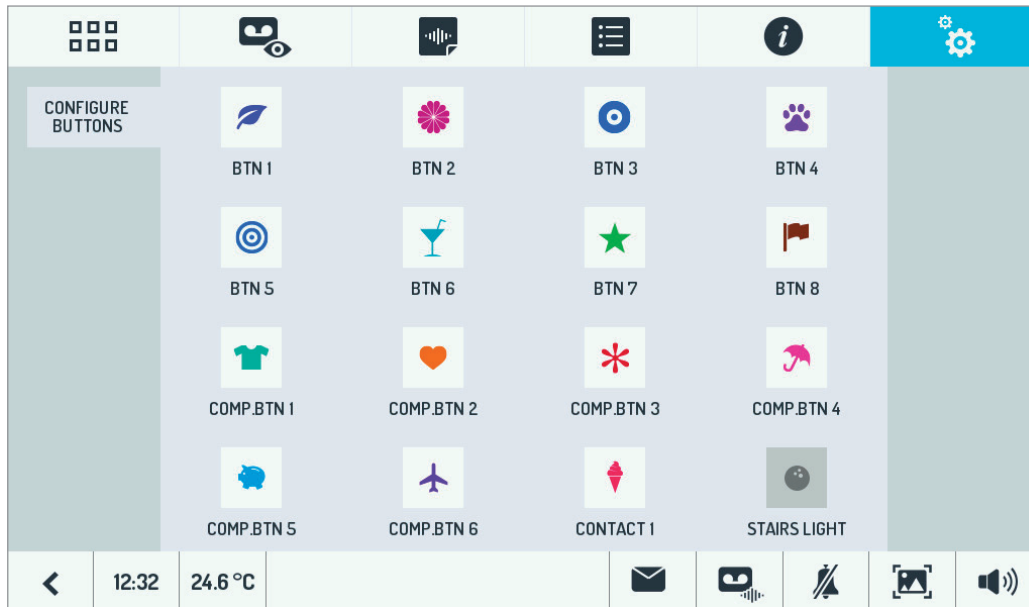

Tap on the Yokis button you want to rename and check (one of the first 8 on top).
The following will appear:

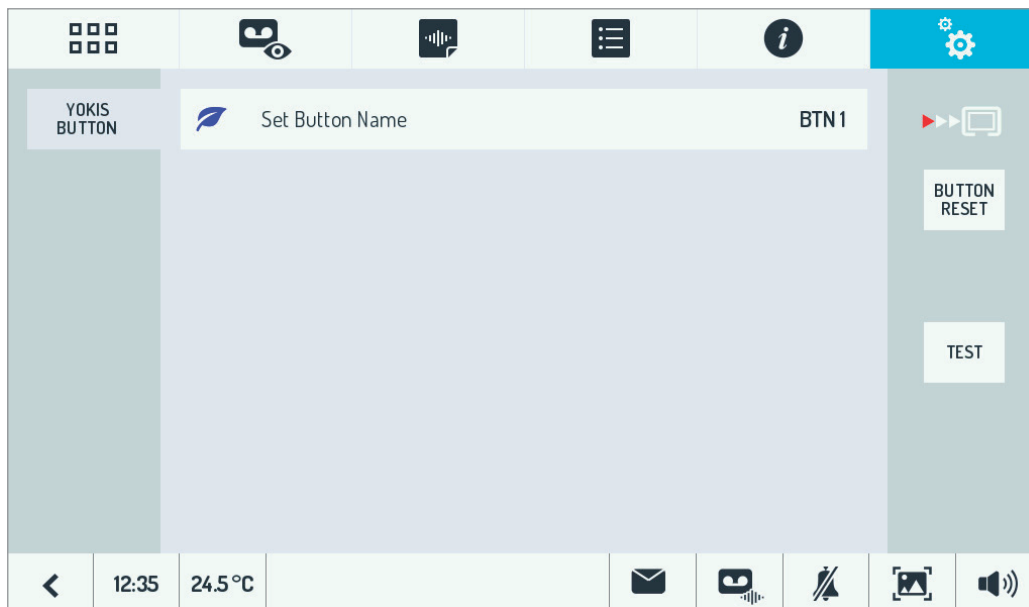

The new icon on the right part of the video door phone indicates that it is a 'Imported Button'.

At this point, you can:

- Import the NAME of the button (the one that the user will see), by tapping on the displayed menu item.
- Check correct operation of the button by pressing the 'Test' button.

It is not possible to make changes to the operation of the imported button, if it is not reset first. To do this, tap the 'Button Reset' button and confirm. Resetting the single button does not change its name. Once the button has been reset, all configuration menu items will appear.

ANNEX C

How to configure the composite buttons

The composite buttons can be used to control multiple Yokis buttons at the same time. In practice, for the end user, pressing a composite button will be equal to pressing the single Yokis buttons it consists of in sequence.

IMPORTANT The scenarios which can be achieved with the Yokis buttons, e.g. simultaneously controlling up to four receiver modules in direct mode or with centralised controls (lighting or shutters). This is possible even more flexibly using the Yokis PRO app. The composite buttons constitute a possible higher degree of aggregation.

Example:

You may have configured one Yokis button to control the centralised locking of all the shutters ('Close All'), in Radio Bus mode, and a second Yokis button to switch on the lights in the living room and kitchen ('Living Room and Kitchen Lights On'), in direct mode.

Now, you can define a composite button ('Evening') which recalls them both and consequently closes all the shutters and at the same time switches on the lights in the living room and kitchen only.

The composite buttons are typical of Urmet video door phones and are not reflected in the Yokis PRO app.

WARNING Obviously, at least two Yokis buttons must have been configured before configuring a composite button otherwise it would serve no purpose.

On the Home Page of the video door phone, press the 'Configuration' icon  select the 'Installer' button, enter the password ('1937'), and then select the 'Home Automation' menu. You will be directed to the following page:

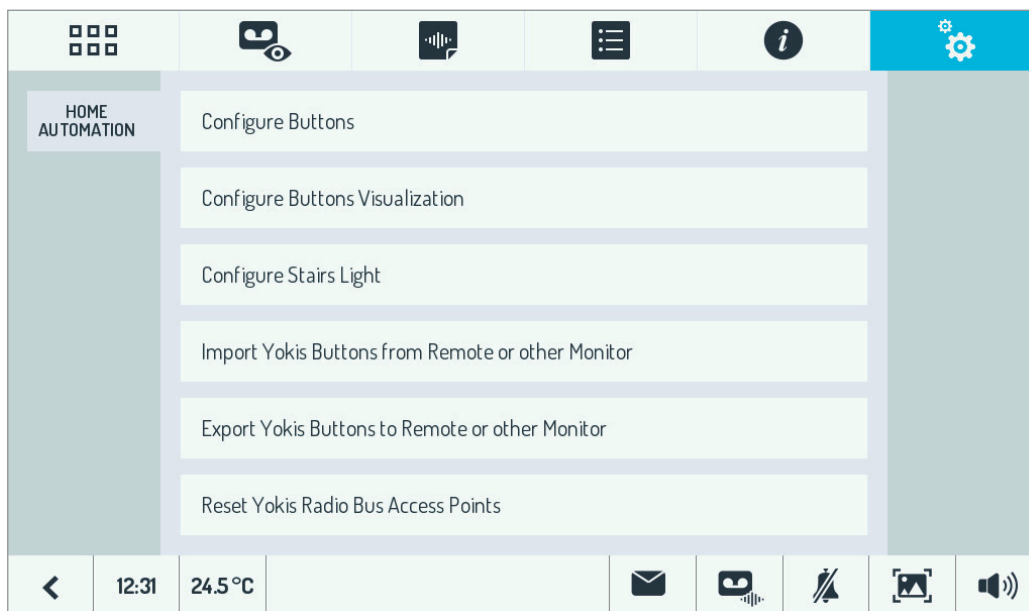

Select 'Configure Buttons' to go to the following page:

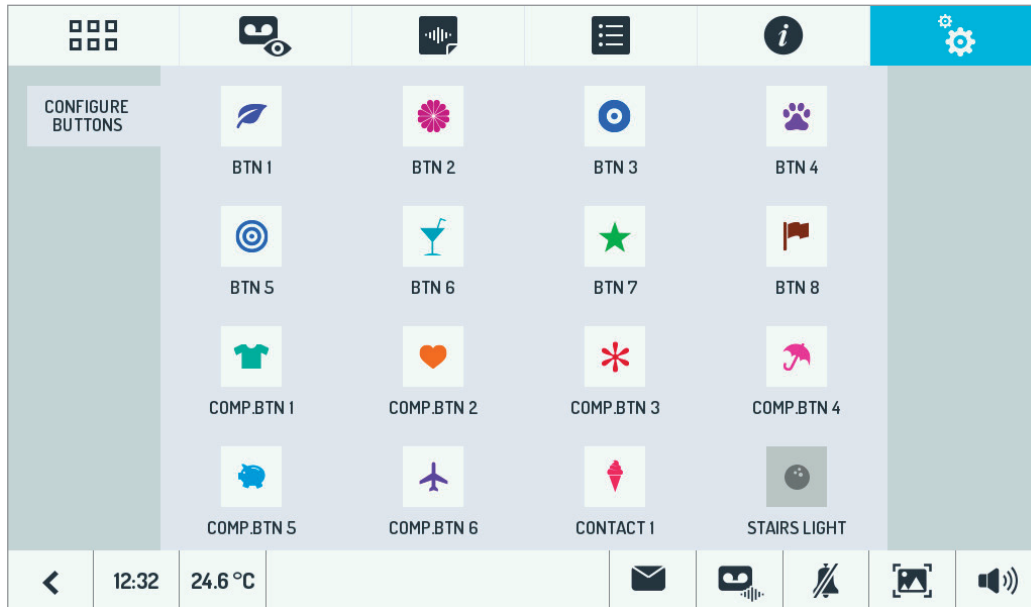

The composite buttons are characterised by the default name 'COMP.BTN N' and are located in the third and fourth row (the two on the left). There are six in total.

Tap on the composite button you want to configure.

The following page will appear:

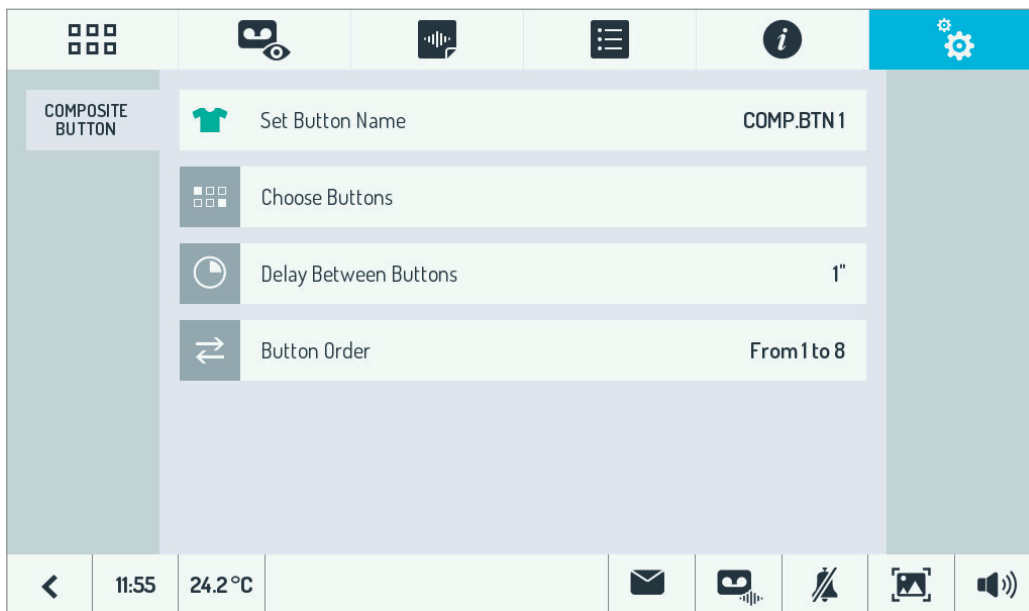

From here you can set four parameters:

- The name of the button (that the user will see).
- The Yokis buttons which will be part of the composition. Tap on all those desired (at least 2):

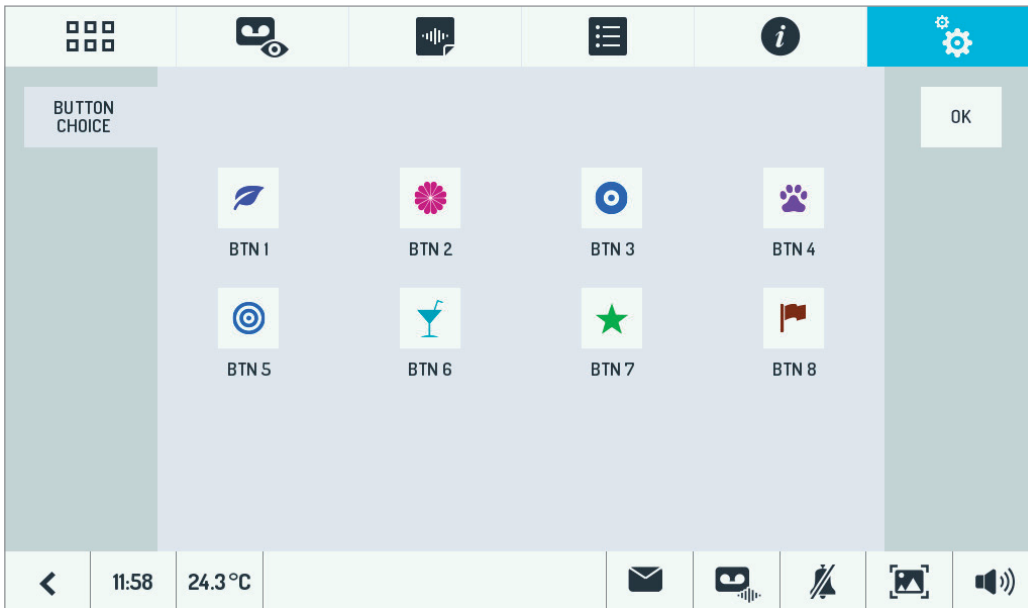

– 'Delay Between Buttons'. The following page will appear:

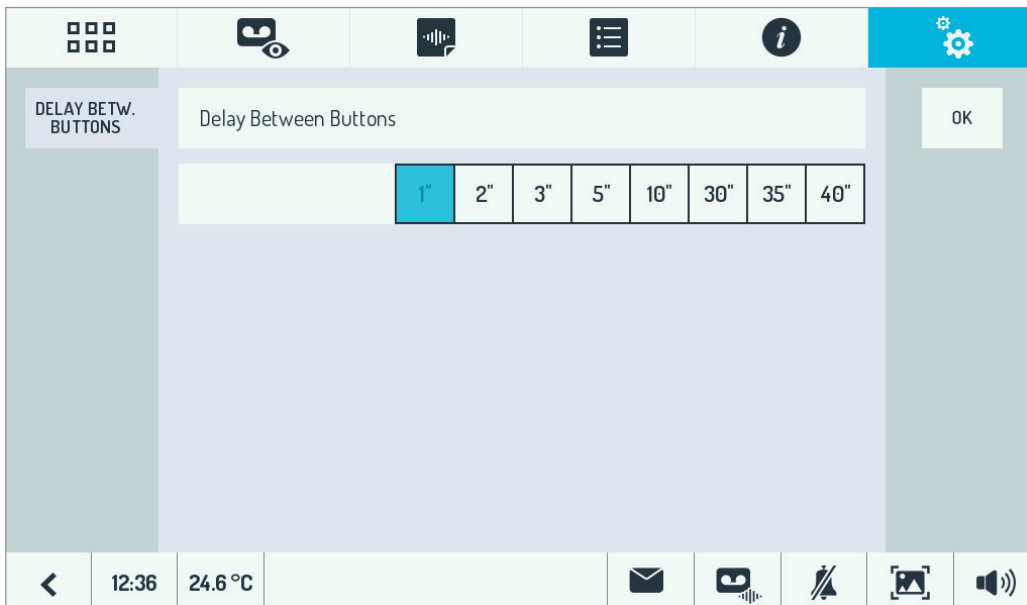

Here you can choose a waiting time between the functions of the single buttons forming the composite. For example, if the composite button controls multiple shutters, it may be useful to introduce a delay so as to operate a single shutter at a time and avoid exceeding the maximum current load.

– The order with which the selected buttons will be activated in sequence from the first to the last or from the last to the first:

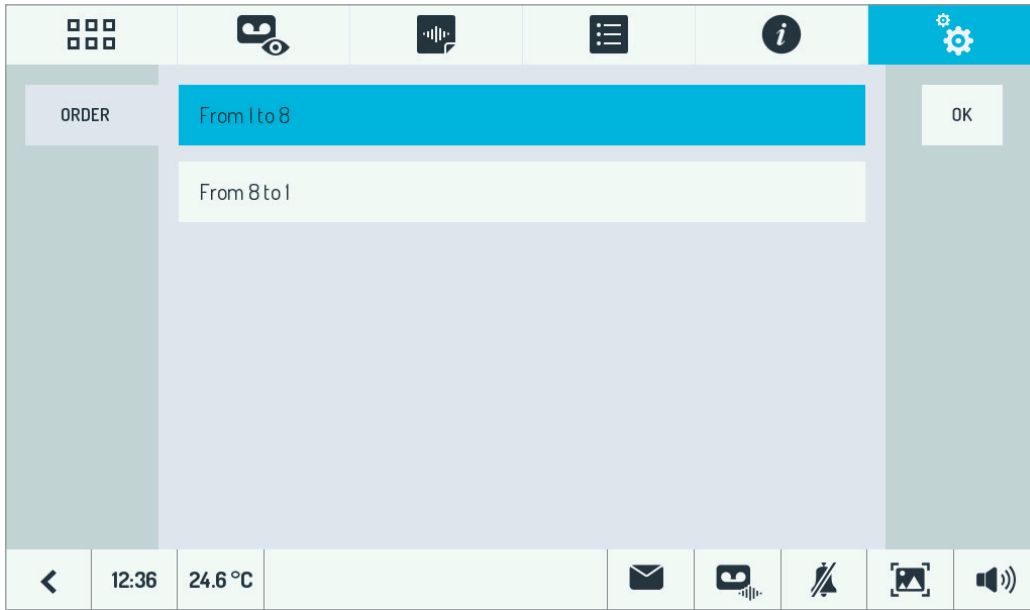

DS 1723-024

URMET S.p.A.
10154 TORINO (ITALY)
VIA BOLOGNA 188/C
Telef. +39 011.24.00.000 (RIC. AUT.)
Fax +39 011.24.00.300 - 323

urmet

LBT 20469

Area tecnica
servizio clienti +39 011.23.39.810
<http://www.urmet.com>
e-mail: info@urmet.com

MADE IN CHINA